



PANAMEDICAL SISTEMAS LTDA.
Rua Borges Lagoa, 423
Vila Clementino CEP 04038-030
São Paulo/SP - Brasil
Telefone 11 2344-1900
www.panamedical.com.br



IMPORTADOR E
DISTRIBUIDOR
EXCLUSIVO

NSK

 **MIZUHO**

 **FEATHER**

 **TOITU**

Mityvac



CENTRO CIRÚRGICO E NEUROCIRURGIA

comercial@panamedical.com.br
11 2344-1903 | 11 94997-0139

GINECO-OBSTETRÍCIA E MOBILIDADE

comercial.e@panamedical.com.br
11 2344-1905 | 11 98129-0112

ASSISTÊNCIA TÉCNICA

atec@panamedical.com.br
11 2344-1908 | 11 96437-0202

LINHA DE PRODUTOS

DÚVIDAS E ORÇAMENTOS

comercial@panamedical.com.br | 11 23441900



Powerful Partners®



Primado2

Total Surgical System

Primado2 Product Lineup

Slim Motor Series

Primado2 Slim Motor **P12**

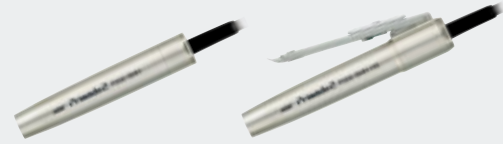

Slim Handpiece 200 **P13**

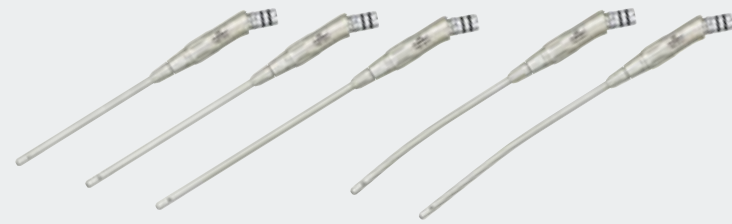

Super Slim Handpiece 200 **P14**



Standard Angled Handpiece 200 **P15**



Standard Straight Handpiece 200 **P16**

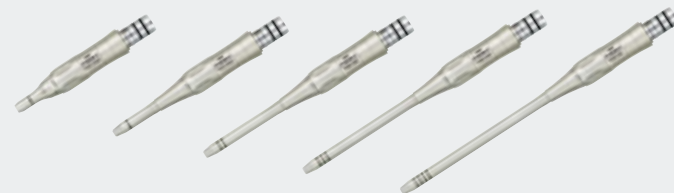

Perforator / Craniotome / Drill **P17-18**



Micro Bone Saw Series

Primado2 Micro Bone Saw **P32-34**

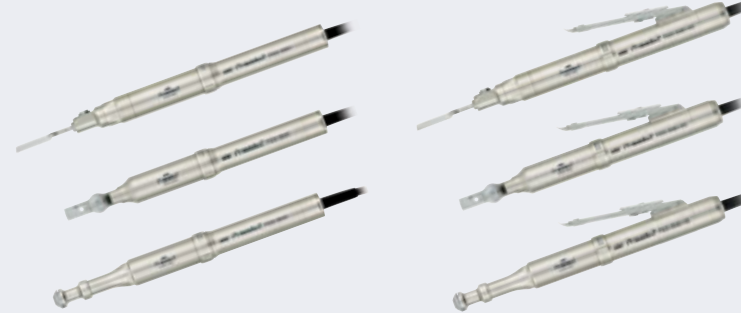

Primado2 Total Surgical System

Primado2 Control Unit **P7-8**



Foot Control

Primado2 Foot Control **P10**

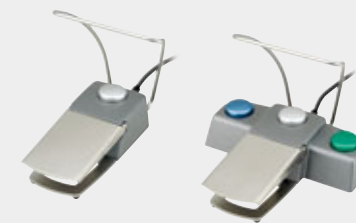

Wire Pin Driver Series

Primado2 Wire Pin Driver **P36**



Wire & Pin Collet **P37**



Drill Attachment **P37**



Reamer Attachment **P38**



Saw Attachment **P38**



High Torque Motor Series

Primado2 High Torque Motor **P20**



High Speed Handpiece 200 **P21**



Slim Handpiece **P23**



Super Slim Handpiece **P24**

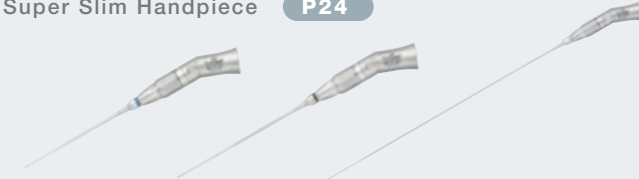

Standard Angled Handpiece **P25**



Standard Straight Handpiece **P26**



Perforator / Craniotome / Drill **P27-29**



Contra Angle Handpiece **P30**



Feel the difference

Primado2 is NSK's second generation electric total surgical system, designed for fulfilling surgeons' demands.

During the five years since NSK have distributed Primado, we have obtained various feedback from surgeons throughout the world. Based on their input, Primado2 is uncompromisingly built to assume maximum quality throughout the product line.

Four strong lineups including the new motor series, Slim Motor, are introduced in Primado2. They consummate excellent cutting, and achieve weight balance during drilling. Thus, using Primado2 is less fatiguing for surgeons, which is especially beneficial during long hours of surgery, and it allows them to concentrate on the operation at hand.

Moreover, the product safety achieved reduces the risk of undesirable events.

Hope you experience the exceptional use that Primado2 provides.



The sign of excellence

Primado2 makes it possible to conduct various types of surgeries. New features include a control unit with a liquid crystal display touch screen, a multifunctional foot control, four lineups of motor handpieces, and extensive attachments. Additionally, easy maintenance is highly valued as all of the Primado2 handpieces and attachments are thermo disinfectant compatible.





Primado2 Control Unit

A 6.5 inch LCD touch screen is newly adopted. The simple design makes it user friendly and easy to use.

Two motor handpieces can be connected to the unit, allowing for easy switching between handpieces.

order code
P200-CU-120

Primado2 Control Unit for 120V

order code
P200-CU-230

Primado2 Control Unit for 230V

- Power Supply : AC120V / 230V 50/60 Hz
- Dimension : W278 x D268 x H160 (mm)
- Weight : 6.9 kg

Settings

Extensive options are available

【Control Unit】

- Brightness • Volume
- Language (English, Japanese, German, French, Spanish, Italian)

【Motor Handpiece】

- Accelerator adjustment (min. 10% - max. 100%)
- Brake adjustment (min. 10% - max. 100%)
- Torque adjustment (min. 30% - 100%)
- Oscillation adjustment (1- 5 times, available only for Wire Pin Driver)

【Attachment】

- Handpiece selection (The rotational speed of the handpiece currently in use appears on the screen.)

Touch Panel

【Main Panel】

- Speed control
- Irrigation control
- Reverse rotation control
- Priming control

【Sub Panel】

- Allows to confirm the assigned functions of each foot control button.

【Mini Panel】

- Button for optional settings.

Configuration Settings

The control unit saves the last configurations made user the Option Set Up button, allowing the operator to proceed right away.

Automatic Recognition for Motor Handpieces

Four types of motor handpieces are automatically recognized by the control unit which displays the corresponding models and rotational speeds for each.

Regulation Equipment- Irrigation Pump

Primado2 comes equipped with an irrigation pump. Irrigation can be adjusted with 5% interval values allowing up to max. 75ml/min.



Primado2 Foot Control

The foot control is available in two models: single (one functional button), and multi (three functional buttons). Each button can be set to a specific function to meet the operator's preference.



Functions are able to be allotted to each button

【 Allocatable Features 】

- Foot control ON/OFF
- A ↔ B control (switching between motor handpieces)
- Speed control
(adjust rotational speed; min. 30% ⇒ default ⇒ max. 100%)
- Reverse rotation mode
- Irrigation ON/OFF
- Flush (continuous 100% irrigation when depressed)
- Disable (disables function to the selected foot control button)



order code
FC-73

Primado2 Single Foot Control

- 1 pedal with button
- Speed control : variable
- IP code: IPX8



order code
FC-74

Primado2 Multi Foot Control

- 1 pedal with 3 buttons
- Speed control : variable
- IP code: IPX8

Slim Motor Series

- Slim Design** : A new design that combines being slim, compact and light, which reduces surgeons' stress during long hour operations.
- High Speed** : High speed rotation of maximum 80,000min⁻¹ makes it possible to cut precisely.
- Versatile** : Various types of handpieces available including a hand control type.
- Easy Maintenance** : All the motors and handpieces can be washed by a thermo disinfectant.
- Durable** : Motors and handpieces are made to be highly durable due to NSK's long years of experience in high precision technology, and are protected with a NSK original special coating called DURACOAT, creating long-lasting and scratch-free quality products.



Primado2 Slim Motor



order code
P200-SMH-HS

Primado2 Slim Motor/HS

- Hand Control type
- Speed: Max. 80,000 min⁻¹
- Available handpieces: 21 kinds
- Bundled Item: Spray Adaptor for Slim (see p.40)

order code
P200-SMH

Primado2 Slim Motor

- Speed: Max. 80,000 min⁻¹
- Available handpieces: 21 kinds
- Bundled Item: Spray Adaptor for Slim (see p.40)

Slim Handpiece 200 for $\varnothing 1.0$ mm bur **80,000 min⁻¹**

The Slim Handpiece 200 has a bur guard tip of 4.8mm in diameter, and is available in various lengths as well as straight and curved models. These deliver excellent performance in endoscopic procedures with limited viewing access. The bur guard can be removed using a wrench that is included with delivery, making maintenance easy.



order code
P200-1A135

Slim Handpiece200 L

- Long type
- Bur: $\varnothing 1.0$ mm / Long

order code
P200-1A155

Slim Handpiece200 EL

- Extra Long type
- Bur: $\varnothing 1.0$ mm / Extra Long

order code
P200-1A175

Slim Handpiece200 SL

- Super Long type
- Bur: $\varnothing 1.0$ mm / Super Long

order code
P200-1A155-C

Slim Handpiece200 EL/Curved

- Extra Long , Curving type
- Bur: $\varnothing 1.0$ mm / Extra Long

order code
P200-1A175-C

Slim Handpiece200 SL/Curved

- Super Long , Curving type
- Bur: $\varnothing 1.0$ mm / Super Long

order code
P200-1ARA-W

Wrench for Slim/Super Slim

- Corresponding wrench for bur guard
- Included with Slim Handpiece 200



Super Slim Handpiece 200 for $\varnothing 1.0$ mm bur **20,000 min⁻¹**

The Super Slim Handpiece 200 is designed with a bur guard tip of 2.1mm in diameter, and can rotate max. 20,000min⁻¹ allowing sensitive drilling in an endoscopic procedure possible. The bur guard can be removed using a wrench that is included with delivery, making maintenance easy.

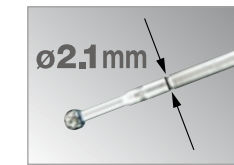

order code
P200-RA135

Super Slim Handpiece200 L

- Long type
- Bur: $\varnothing 1.0$ mm / Long

order code
P200-RA155

Super Slim Handpiece200 EL

- Extra Long type
- Bur: $\varnothing 1.0$ mm / Extra Long

order code
P200-RA330

Super Slim Handpiece200 SPL

- Special Long type
- Bur: $\varnothing 1.0$ mm / Special Long

order code
P200-1ARA-W

Wrench for Slim/Super Slim

- Corresponding wrench for bur guard
- Included with Super Slim Handpiece 200



Standard Angled Handpiece 200 for ø2.35 mm bur **80,000 min⁻¹**

Five different length of handpieces are available with the Standard Angled Handpiece 200. This allows surgeons to deal with various types of operations. Perfect rotation balance and cutting balance performance are achieved.



order code
P200-2AMS

Std. Angled Handpiece200 MS

- Mini type
- Bur: ø2.35mm / MS

order code
P200-2AES

Std. Angled Handpiece200 ES

- Extra Short type
- Bur: ø2.35mm / Extra Short

order code
P200-2AS

Std. Angled Handpiece200 S

- Short type
- Bur: ø2.35mm / Short

order code
P200-2AM

Std. Angled Handpiece200 M

- Medium type
- Bur: ø2.35mm / Medium

order code
P200-2AL

Std. Angled Handpiece200 L

- Long type
- Bur: ø2.35mm / Long

Irrigation Nozzle

order code
PD-IN-D
For P200-2AMS (MS)

order code
PD-IN-2ES
For P200-2AES (ES)

order code
PD-IN-2S
For P200-2AS (S)

order code
PD-IN-2M
For P200-2AM (M)

order code
PD-IN-2L
For P200-2AL (L)

Standard Straight Handpiece 200 for ø2.35 mm bur **80,000 min⁻¹**

Five different length of handpieces are available with the Standard Straight Handpiece 200. This allows surgeons to deal with various types of operations. Perfect rotation balance and cutting balance performance are achieved.



order code
P200-2SMS

Std. Straight Handpiece200 MS

- Mini type
- Bur: ø2.35mm / MS

order code
P200-2SES

Std. Straight Handpiece200 ES

- Extra Short type
- Bur: ø2.35mm / Extra Short

order code
P200-2SS

Std. Straight Handpiece200 S

- Short type
- Bur: ø2.35mm / Short

order code
P200-2SM

Std. Straight Handpiece200 M

- Medium type
- Bur: ø2.35mm / Medium

order code
P200-2SL

Std. Straight Handpiece200 L

- Long type
- Bur: ø2.35mm / Long

Irrigation Nozzle

order code
PD-IN-D
For P200-2SMS (MS)

order code
PD-IN-2ES
For P200-2SES (ES)

order code
PD-IN-2S
For P200-2SS (S)

order code
PD-IN-2M
For P200-2SM (M)

order code
PD-IN-2L
For P200-2SL (L)

Perforator Handpiece 200 1,250 min⁻¹

The high performance handpiece for trephination. It delivers stable torque and achieves smooth and powerful cutting performance.



order code
P200-PER
Perforator Handpiece200
• Compatible Chuck: Hudson Chuck

Drill Handpiece 200 for ø2.35 mm Twist Drill 80,000 min⁻¹

The corresponding handpiece for a trephination.



order code
P200-2SD
Straight Drill Handpiece200
• Bur: ø2.35mm twist drill



Irrigation Nozzle
order code
PD-IN-D
For P200-2SD

Craniotome Handpiece 200 for ø3.17 mm bur 80,000 min⁻¹

The high performance handpiece designed for cranial surgery. Three different types of duraguards are available for variable cranial bone thickness. The smooth and powerful cutting performance avoids adding additional stress to the surgeon.



order code
P200-CRA
Craniotome Handpiece200
• Bur: Craniotome bur, Router bur
• Bundled Item: P200-CRD-M



order code
P200-CRD-P
Pediatric Duraguard200
• Bur: Pediatric Craniotome bur,
Pediatric Router bur



order code
P200-CRD-M
Medium Duraguard200
• Bur: Medium Craniotome bur,
Medium Router bur



order code
P200-CRD-L
Long Duraguard200
• Bur: Long Craniotome bur,
Long Router bur

High Torque Motor Series

High Torque : High torque motor delivers advanced cutting performance.

Versatile : Standard and hand control type are newly introduced.

Easy Maintenance : All of the motors and handpieces can be washed by a thermo disinfecter.



Primado2 High Torque Motor



order code
P200-HMH-HS

Primado2 High Torque Motor/HS

- Hand Control type
- Speed: Max. 60,000 min⁻¹
- Available handpieces: 24 kinds

order code
P200-HMH

Primado2 High Torque Motor

- Speed: Max. 60,000 min⁻¹
- Available handpieces: 24 kinds



High Speed Handpiece 200 for ø3.17 mm bur **100,000 min⁻¹**

A maximum rotational speed of 100,000 min⁻¹ is attained with use of the motor increaser.
Its powerful cutting performance is most suitable for open surgery.



order code
P200-3GAS

High Speed Handpiece200 S

- Short type
- Bur: ø3.17mm / Short

order code
P200-3GAM

High Speed Handpiece200 M

- Medium type
- Bur: ø3.17mm / Medium

order code
P200-3GAL

High Speed Handpiece200 L

- Long type
- Bur: ø3.17mm / Long

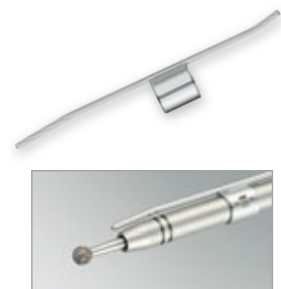

Irrigation Nozzle

order code
PD-IN-3S
For P200-3GAS (S)

order code
PD-IN-3M
For P200-3GAM (M)

order code
PD-IN-3L
For P200-3GAL (L)

Slim Handpiece

for $\varnothing 1.0$ mm bur **60,000 min⁻¹**

The Slim Handpiece has a narrow bur guard tip of 4.8mm in diameter. It allows direct visualization of a bur in surgical procedures with limited viewing access.



order code
PD-1A135

Long Slim Handpiece

- Long type
- Bur: $\varnothing 1.0$ mm / Long

order code
PD-1A155-10

Extra Long Slim Handpieces with a curvature of 10°

- Extra Long type
- Bur: $\varnothing 1.0$ mm / Extra Long

order code
PD-1A175-10

Super Long Slim Handpieces with a curvature of 10°

- Super Long type
- Bur: $\varnothing 1.0$ mm / Super Long

Super Slim Handpiece

for $\varnothing 1.0$ mm bur **24,000 min⁻¹**

The Super Slim Handpiece is designed with a bur guard tip of 2.1mm in diameter. Maximum rotational speed of 24,000 min⁻¹ allows sensitive cutting in endoscopic operations possible.

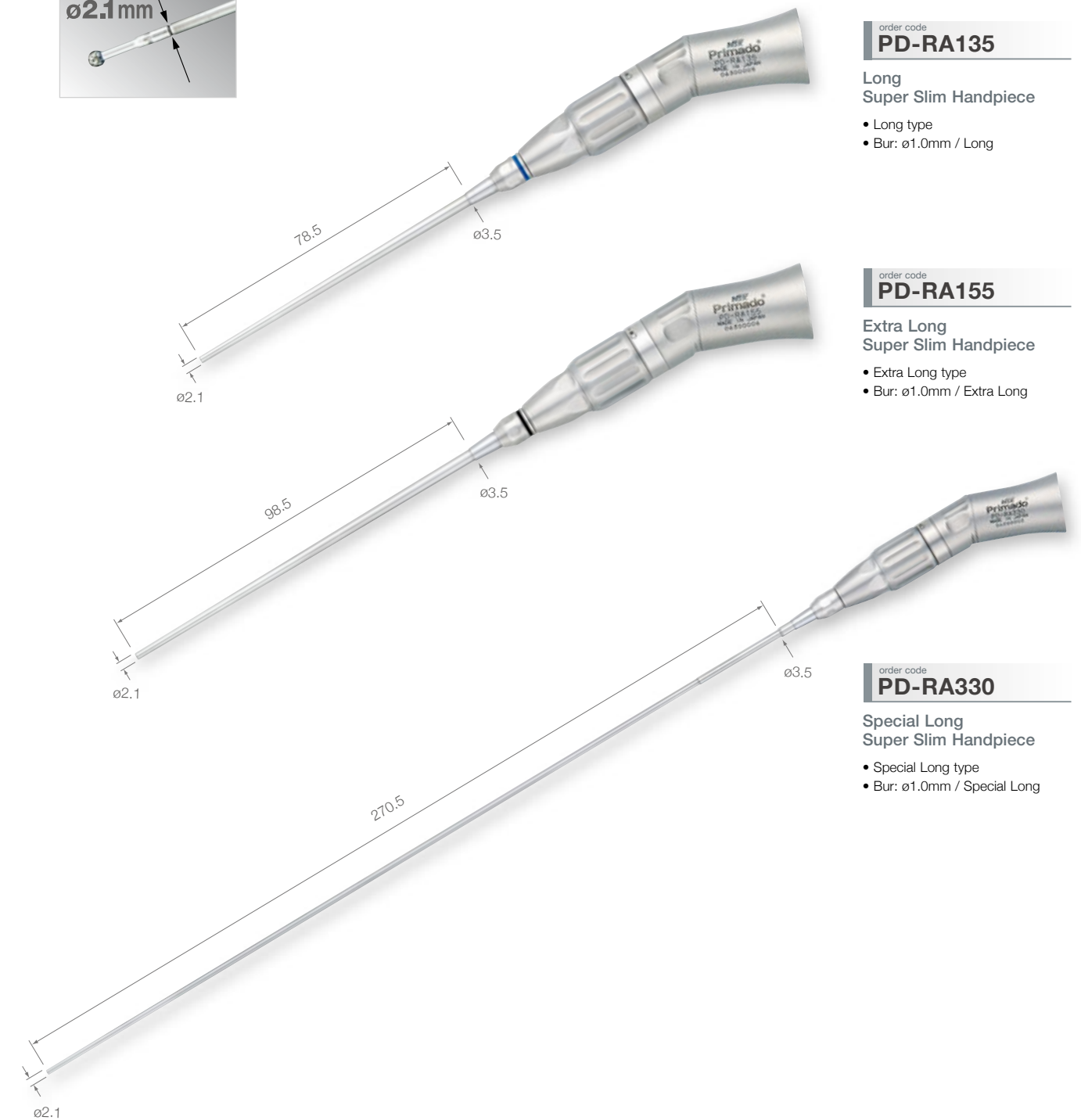
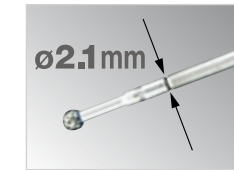

order code
PD-RA135

Long Super Slim Handpiece

- Long type
- Bur: $\varnothing 1.0$ mm / Long

order code
PD-RA155

Extra Long Super Slim Handpiece

- Extra Long type
- Bur: $\varnothing 1.0$ mm / Extra Long

order code
PD-RA330

Special Long Super Slim Handpiece

- Special Long type
- Bur: $\varnothing 1.0$ mm / Special Long

Standard Angled Handpiece for $\varnothing 2.35$ mm bur **60,000 min⁻¹**

The Standard Angled Handpiece comes available in four different lengths to support diverse procedures, each with excellent cutting performance and stability.



order code
PD-2AES

Extra Short
Standard Angle Handpiece

- Extra Short type
- Bur: $\varnothing 2.35$ mm / Extra Short

order code
PD-2AS

Short
Standard Angle Handpiece

- Short type
- Bur: $\varnothing 2.35$ mm / Short

order code
PD-2AM

Medium
Standard Angle Handpiece

- Medium type
- Bur: $\varnothing 2.35$ mm / Medium

order code
PD-2AL

Long
Standard Angle Handpiece

- Long type
- Bur: $\varnothing 2.35$ mm / Long

Irrigation Nozzle

order code
PD-IN-2ES
For PD-2AES (ES)

order code
PD-IN-2S
For PD-2AS (S)

order code
PD-IN-2M
For PD-2AM (M)

order code
PD-IN-2L
For PD-2AL (L)



Standard Straight Handpiece for $\varnothing 2.35$ mm bur **60,000 min⁻¹**

The Standard Straight Handpiece comes available in three different lengths to support diverse procedures, each with excellent cutting performance and stability.



order code
PD-2SES

Extra Short
Standard Straight Handpiece

- Extra Short type
- Bur: $\varnothing 2.35$ mm / Extra Short

order code
PD-2SS

Short
Standard Straight Handpiece

- Short type
- Bur: $\varnothing 2.35$ mm / Short

order code
PD-2SM

Medium
Standard Straight Handpiece

- Medium type
- Bur: $\varnothing 2.35$ mm / Medium

Irrigation Nozzle

order code
PD-IN-2ES
For PD-2SES (ES)

order code
PD-IN-2S
For PD-2SS (S)

order code
PD-IN-2M
For PD-2SM (M)



Perforator Handpiece

1,200 min⁻¹

The high performance handpiece for trephination. It delivers stable torque, and achieves smooth and strong cutting performance.



order code
PD-PER

Perforator Handpiece

- Compatible Chuck: Hudson Chuck

Craniotome Handpiece

for ø3.17 mm bur

60,000 min⁻¹

The high quality handpiece designed for craniotomy. Three different types of duraguards are available for variable cranial bone thickness. Strong cutting performance assists in a smooth operation.



order code
PD-CRA

Craniotome Handpiece

- Bur: Craniotome bur, Router bur
- Bundled Item: PD-CRD-M

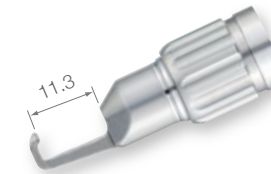

order code
PD-CRD-P

Pediatric Duraguard

- Bur: Pediatric Craniotome bur, Pediatric Router bur



order code
PD-CRD-M

Medium Duraguard

- Bur: Medium Craniotome bur, Medium Router bur

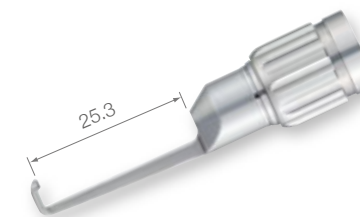

order code
PD-CRD-L

Long Duraguard

- Bur: Long Craniotome bur, Long Router bur

Drill Handpiece for ø2.35 mm Twist Drill **60,000 min⁻¹**

The corresponding handpiece for a trephination. The NSK Drill Handpiece is available in straight and angled models for various types of operations.



order code
PD-2SD

Straight Drill Handpiece

- Bur: ø2.35 mm Twist Drill



order code
PD-2SDM

Straight Drill Handpiece M

- Corresponds to ø2.35mm burs



order code
PD-2AD

Angled Drill Handpiece

- Bur: ø2.35 mm Twist Drill



order code
PD-2ADM

Angled Drill Handpiece M

- Corresponds to ø2.35mm burs



Irrigation Nozzle

order code
PD-IN-D

For PD-2SD, PD-2AD

order code
PD-IN-2ES

For PD-2SDM, PD-2ADM



Contra Angle Handpiece

The Contra Angle Handpiece is useful when approaching at a blind angle. It is available in two types of speed reduction: 16:1 and 64:1.



order code
PD-CA-16

**Contra Angle Handpiece
16:1 Reduction**

- 16:1 Reduction (Speed: Max. 3,750 min⁻¹)
- Latch Type Chuck
- Corresponds to ø2.35mm CA burs



order code
PD-CA-64

**Contra Angle Handpiece
64:1 Reduction**

- 64:1 Reduction (Speed: Max. 940 min⁻¹)
- Latch Type Chuck
- Corresponds to ø2.35mm CA burs

Micro Bone Saw Series

- Slim Design** : The streamlined design with the reduced weight delivers well-balanced handling.
- High Performance** : Excellent cutting performance paired with low rotational vibration creates smooth operation.
- Easy Maintenance** : All of the motors and handpieces can be washed by a thermo disinfectant.
- Durable** : Motors and handpieces are made to be highly durable due to NSK's long years of experience in high precision technology, and are protected with a NSK original special coating called DURACOAT, creating long-lasting and scratch-free quality products.



Primado2 Reciprocating Saw Handpiece 20,000 min⁻¹



order code
P200-REC-S

Primado2 Rec. Handpiece

- Speed: Max. 20,000 min⁻¹
- Stroke Length: 2.5 mm
- Blade: Reciprocating Saw Blades, Reciprocating Rasps
- Bundled Item: Spray Adaptor for Bone Saw (see p.40)



order code
P200-REC-S-HS

Primado2 Rec. Handpiece/HS

- Hand Control type
- Speed: Max. 20,000 min⁻¹
- Stroke Length: 2.5 mm
- Blade: Reciprocating Saw Blades, Reciprocating Rasps
- Bundled Item: Spray Adaptor for Bone Saw (see p.40)



Irrigation Nozzle

order code
P200-IN-BS
For P200-REC-S, P200-REC-S-HS



Primado2 Reciprocating Saw Handpiece

Primado2 Sagittal Saw Handpiece

Primado2 Oscillating Saw Handpiece



order code
P200-SAG-S

Primado2 Sag. Handpiece

- Speed: Max. 20,000 min⁻¹
- Angle of Oscillation: 8°
- Blade: Sagittal and Oscillating Saw Blades
- Bundled Item: Spray Adaptor for Bone Saw (see p.40)



order code
P200-OSC-S

Primado2 Osc. Handpiece

- Speed: Max. 20,000 min⁻¹
- Angle of Oscillation: 8°
- Blade: Sagittal and Oscillation Saw Blades, Oscillating Saw Blades (for Intra Oral)
- Bundled Item: Spray Adaptor for Bone Saw (see p.40)



order code
P200-SAG-S-HS

Primado2 Sag. Handpiece/HS

- Hand Control type
- Speed: Max. 20,000 min⁻¹
- Angle of Oscillation: 8°
- Blade: Sagittal and Oscillating Saw Blades
- Bundled Item: Spray Adaptor for Bone Saw (see p.40)



order code
P200-OSC-S-HS

Primado2 Osc. Handpiece/HS

- Hand Control type
- Speed: Max. 20,000 min⁻¹
- Angle of Oscillation: 8°
- Blade: Sagittal and Oscillation Saw Blades, Oscillating Saw Blades (for Intra Oral)
- Bundled Item: Spray Adaptor for Bone Saw (see p.40)



order code
PD-OSC-A

Adaptor

- Blade: Oscillating Saw Blades (for Intra Oral)
- Bundled Item: Corresponding wrench(1), and screws (2)



order code
P200-IN-BS

For P200-SAG-S, P200-SAG-S-HS



order code
P200-IN-BS

For P200-OSC-S, P200-OSC-S-HS

Wire Pin Driver Series

Powerful : Delivers powerful pinning, wiring, and drilling through elaborate design.

Ergonomic Design : Smart design lies comfortably in the surgeon's hand and creates smooth handling and high operability.

Easy Maintenance : All of the motors and attachments can be washed by a thermo disinfectant.



Wire & Pin Collet

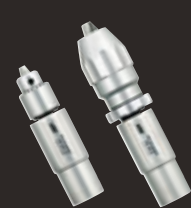

Drill Attachment



Reamer Attachment



Saw Attachment

Primado2 Wire Pin Driver



order code
P200-WPD

Primado2 Wire Pin Driver

- Speed : Max. 1,200 min⁻¹
- Rotation Mode: Forward, Reverse, Oscillating
- Bundled Item: Spray Adaptor (see p.40)

Wire & Pin Collet

1,200 min⁻¹



order code
PD-DA-W

Primado Wire Collet
• ø0.6-ø1.9 mm



order code
PD-DA-P

Primado Pin Collet
• ø2.0-ø3.2 mm

Drill Attachment

1,200 min⁻¹



order code
PD-DA-J4

Jacobs Keyed Drill Chuck
• ø0.5-ø4.0 mm



Bundled Item: T wrench

order code
PD-DA-J6

Jacobs Keyed Drill Chuck
• ø0.5-ø6.5 mm



Bundled Item: T wrench

order code
PD-DA-A

AO Drill Chuck

order code
PD-DA-K

Keyless Drill Chuck

Reamer Attachment

300 min⁻¹



order code
PD-RA-M

Hudson Modified
Trinkle Reamer

order code
PD-RA-H

Hudson Reamer

order code
PD-RA-T

Trinkle Reamer

order code
PD-RA-A

AO Reamer

Saw Attachment

12,000 min⁻¹



order code
PD-SA-R

Reciprocating Saw
Attachment

• Blade: Reciprocating Saw Blades,
Reciprocating Rasps

order code
PD-SA-S

Sagittal Saw Attachment

• Blade: Sagittal and Oscillating Saw Blades

Sterilization Case

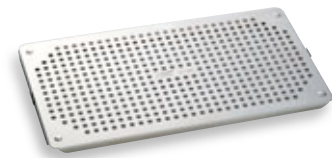

order code
SC-ML
Sterilization Metal Lid



order code
SC-T-F
Sterilization Tray Divider-Free
• Dimensions :
W480 x D250 x H60 (mm)

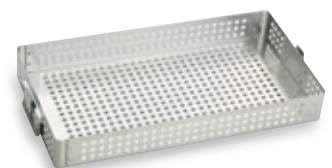

order code
SC-C-H70
Sterilization Case/H70
• Dimensions :
W512 x D262 x H70 (mm)

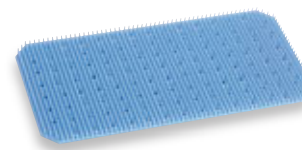

order code
SC-SM
Silicone Mat
• The mat for the Sterilization Tray



order code
SC-C-H125
Sterilization Case/H125
• Dimensions :
W512 x D262 x H125 (mm)

Mobile Trolley

NSK offers a specially designed mobile trolley for the Primado control unit which is not only practical but also elegant. In this way, all the equipment can be stored in one place allowing easy access when needed. The trolley has adjustable height, lockable wheels and a bracket for the cable on the side.



order code
Z299
iCart-L Mobile Trolley
• Dimensions :
W360 x D420 x H800 (mm)
• Weight : 10 kg

Irrigation Tube



order code
PD-IT-S
Surgical Irrigation Tube
• Pack of 10 (Sterilized)

Maintenance

PANA SPRAY Plus is a specially formulated, highly effective general handpiece lubricant. Frequent application of PANA SPRAY Plus will assure handpiece performance and durability. Apply PANA SPRAY Plus to handpieces after "Cleaning" in the maintenance process.

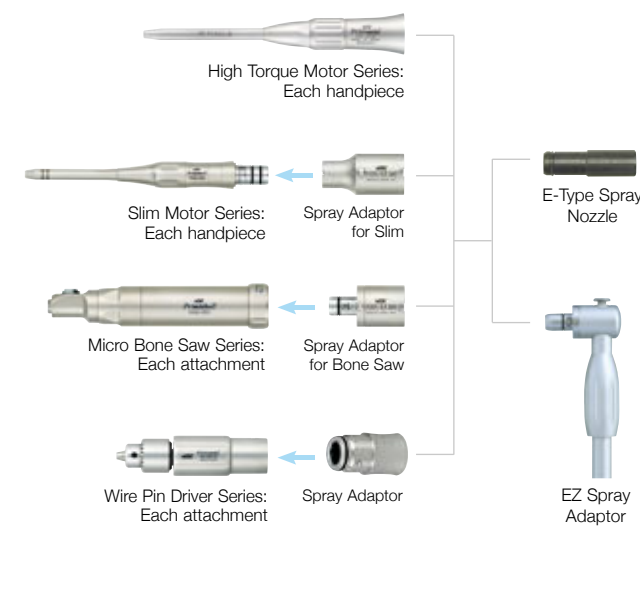

order code
Z182100
PANA Spray Plus
• For Handpieces, 480 mL
• Alcohol-contained Lubricant

order code
Y900630
PANA Spray Plus (6pcs)
• Pack of 6

order code
Z019090
E-Type Spray Nozzle
• For Handpieces

order code
PD-EZ-M
EZ Spray Adaptor
• PANA Spray Plus is not included

Spray Mist Absorber

A convenient way to avoid mist spray from escaping into the environment. Simply insert the handpiece into the Absorber Pack then apply the spray lubricant.



order code
Y900084
Spray Mist Absorber
• Pack of 10

NSK



Powerful Partners®



Primado 2

Cutting Accessories

NAKANISHI INC.  www.nsk-surgery.com
700 Shimohinata Kanuma-shi Tochigi 322-8666, Japan
TEL : +81 (0)289-64-3380 FAX : +81 (0)289-64-3890

NSK Europe GmbH 
Elly-Beinhorn-Strasse 8 65760 Eschborn, Germany
TEL : +49 (0)6196 77606-0 FAX : +49 (0)6196 77606-29

Specifications are subject to change without notice. All products are sterilized.

REF PR-M035E Ver.1 12.06.02.A

ROTARY INSTRUMENTS $\varnothing 1.0\text{mm}$

ROTARY INSTRUMENTS $\varnothing 2.35\text{mm}$

Diamond Burs

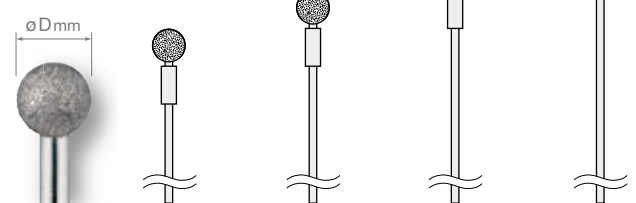

D Head Diameter	Long	Extra Long	Super Long	Special Long
	for P200-1A135 P200-RA135 PD-1A135 PD-RA135	for P200-1A155 P200-1A155-C P200-RA155 PD-1A155-10 PD-RA155	for P200-1A175 P200-1A175-C PD-1A175-10	for P200-RA330 PD-RA330
2.0	PDS-1D135-20	PDS-1D155-20	PDS-1D175-20	PDS-1D330-20
2.5	—	—	—	PDS-1D330-25
3.0	PDS-1D135-30	PDS-1D155-30	PDS-1D175-30	PDS-1D330-30
3.5	—	—	—	PDS-1D330-35
4.0	PDS-1D135-40	PDS-1D155-40	PDS-1D175-40	—

Neuro Diamond Burs

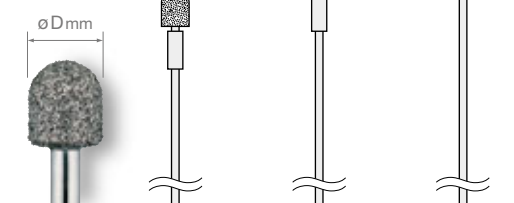

D Head Diameter	Long	Extra Long	Super Long
	for P200-1A135 P200-RA135 PD-1A135 PD-RA135	for P200-1A155 P200-1A155-C P200-RA155 PD-1A155-10 PD-RA155	for P200-1A175 P200-1A175-C PD-1A175-10
2.0	PDS-1ND135-20	PDS-1ND155-20	PDS-1ND175-20
3.0	PDS-1ND135-30	PDS-1ND155-30	PDS-1ND175-30
4.0	PDS-1ND135-40	PDS-1ND155-40	PDS-1ND175-40

Round Fluted Burs

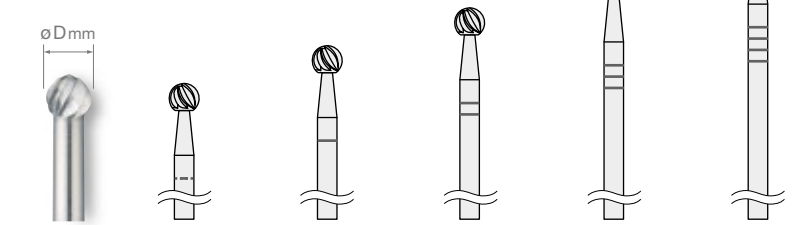

D Head Diameter	MS	Extra Short	Short	Medium	Long
	for P200-2AMS P200-2SMS	for P200-2AES P200-2SES PD-2AES PD-2SES	for P200-2AS P200-2SS PD-2AS PD-2SS	for P200-2AM P200-2SM PD-2AM PD-2SM	for P200-2AL P200-2SL PD-2AL
1.0	PDS-2CMS-10	PDS-2CES-10	PDS-2CS-10	PDS-2CM-10	—
2.0	PDS-2CMS-20	PDS-2CES-20	PDS-2CS-20	PDS-2CM-20	PDS-2CL-20
3.0	PDS-2CMS-30	PDS-2CES-30	PDS-2CS-30	PDS-2CM-30	PDS-2CL-30
4.0	PDS-2CMS-40	PDS-2CES-40	PDS-2CS-40	PDS-2CM-40	PDS-2CL-40
5.0	PDS-2CMS-50	PDS-2CES-50	PDS-2CS-50	PDS-2CM-50	PDS-2CL-50
6.0	PDS-2CMS-60	PDS-2CES-60	PDS-2CS-60	PDS-2CM-60	PDS-2CL-60
7.0	PDS-2CMS-70	PDS-2CES-70	PDS-2CS-70	PDS-2CM-70	PDS-2CL-70

Coarse Diamond Burs

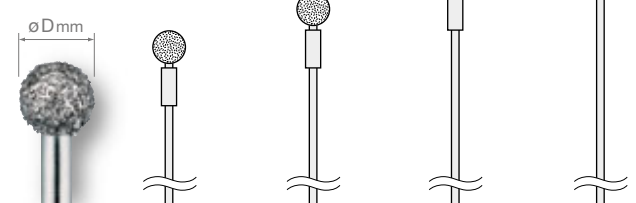

D Head Diameter	Long	Extra Long	Super Long	Special Long
	for P200-1A135 P200-RA135 PD-1A135 PD-RA135	for P200-1A155 P200-1A155-C P200-RA155 PD-1A155-10 PD-RA155	for P200-1A175 P200-1A175-C PD-1A175-10	for P200-RA330 PD-RA330
2.0	PDS-1CD135-20	PDS-1CD155-20	PDS-1CD175-20	PDS-1CD330-20
2.5	—	—	—	PDS-1CD330-25
3.0	PDS-1CD135-30	PDS-1CD155-30	PDS-1CD175-30	PDS-1CD330-30
3.5	—	—	—	PDS-1CD330-35
4.0	PDS-1CD135-40	PDS-1CD155-40	PDS-1CD175-40	—

Neuro Coarse Diamond Burs

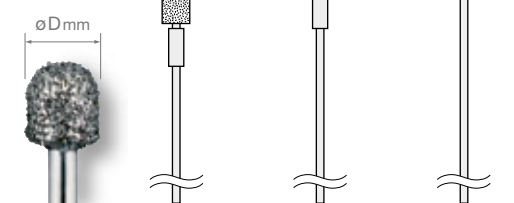

D Head Diameter	Long	Extra Long	Super Long
	for P200-1A135 P200-RA135 PD-1A135 PD-RA135	for P200-1A155 P200-1A155-C P200-RA155 PD-1A155-10 PD-RA155	for P200-1A175 P200-1A175-C PD-1A175-10
2.0	PDS-1NCD135-20	PDS-1NCD155-20	PDS-1NCD175-20
3.0	PDS-1NCD135-30	PDS-1NCD155-30	PDS-1NCD175-30
4.0	PDS-1NCD135-40	PDS-1NCD155-40	PDS-1NCD175-40

Diamond Burs

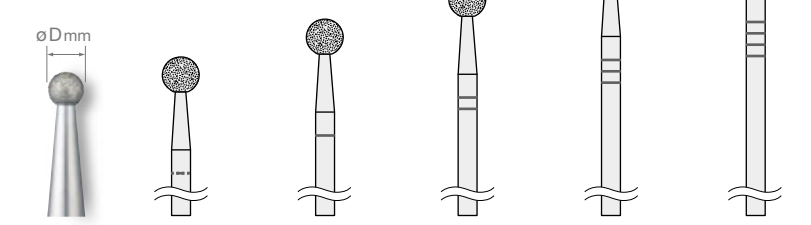

D Head Diameter	MS	Extra Short	Short	Medium	Long
	for P200-2AMS P200-2SMS	for P200-2AES P200-2SES PD-2AES PD-2SES	for P200-2AS P200-2SS PD-2AS PD-2SS	for P200-2AM P200-2SM PD-2AM PD-2SM	for P200-2AL P200-2SL PD-2AL
0.6	PDS-2DMS-06	PDS-2DES-06	PDS-2DS-06	—	—
1.0	PDS-2DMS-10	PDS-2DES-10	PDS-2DS-10	PDS-2DM-10	—
1.5	PDS-2DMS-15	PDS-2DES-15	PDS-2DS-15	—	—
2.0	PDS-2DMS-20	PDS-2DES-20	PDS-2DS-20	PDS-2DM-20	PDS-2DL-20
3.0	PDS-2DMS-30	PDS-2DES-30	PDS-2DS-30	PDS-2DM-30	PDS-2DL-30
4.0	PDS-2DMS-40	PDS-2DES-40	PDS-2DS-40	PDS-2DM-40	PDS-2DL-40
5.0	PDS-2DMS-50	PDS-2DES-50	PDS-2DS-50	PDS-2DM-50	PDS-2DL-50
6.0	PDS-2DMS-60	PDS-2DES-60	PDS-2DS-60	PDS-2DM-60	PDS-2DL-60
7.0	PDS-2DMS-70	PDS-2DES-70	PDS-2DS-70	PDS-2DM-70	PDS-2DL-70

P200-1A135 L
P200-1A155 EL
P200-1A155-C EL
P200-1A175 SL
P200-1A175-C SL

P200-RA135 L
P200-RA155 EL
P200-RA330 SPL

PD-1A135 L
PD-1A155-10 EL
PD-1A175-10 SL

PD-RA135 L
PD-RA155 EL
PD-RA330 SPL

P200-2AMS MS
P200-2AES ES
P200-2AS S
P200-2AM M
P200-2AL L

P200-2SMS MS
P200-2SES ES
P200-2SS S
P200-2SM M
P200-2SL L

PD-2AES ES
PD-2AS S
PD-2AM M
PD-2AL L

PD-2SES ES
PD-2SS S
PD-2SM M

ROTARY INSTRUMENTS $\varnothing 2.35\text{mm}$

Coarse Diamond Burs



D Head Diameter	MS	Extra Short	Short	Short [Extended]	Medium	Medium [Extended]	Long	Long [Extended]
	for P200-2AMS P200-2SMS	for P200-2AES P200-2SES PD-2AES PD-2SES	for P200-2AS P200-2SS PD-2AS PD-2SS	for P200-2AS P200-2SS PD-2AS PD-2SS	for P200-2AM P200-2SM PD-2AM PD-2SM	for P200-2AM P200-2SM PD-2AM PD-2SM	for P200-2AL P200-2SL PD-2AL	for P200-2AL P200-2SL PD-2AL
2.0	PDS-2CDMS-20	PDS-2CDES-20	PDS-2CDS-20	PDS-2CDS-20E	PDS-2CDM-20	PDS-2CDM-20E	PDS-2CDL-20	PDS-2CDL-20E
3.0	PDS-2CDMS-30	PDS-2CDES-30	PDS-2CDS-30	PDS-2CDS-30E	PDS-2CDM-30	PDS-2CDM-30E	PDS-2CDL-30	PDS-2CDL-30E
4.0	PDS-2CDMS-40	PDS-2CDES-40	PDS-2CDS-40	PDS-2CDS-40E	PDS-2CDM-40	PDS-2CDM-40E	PDS-2CDL-40	PDS-2CDL-40E
5.0	PDS-2CDMS-50	PDS-2CDES-50	PDS-2CDS-50	PDS-2CDS-50E	PDS-2CDM-50	PDS-2CDM-50E	PDS-2CDL-50	PDS-2CDL-50E
6.0	PDS-2CDMS-60	PDS-2CDES-60	PDS-2CDS-60	—	PDS-2CDM-60	—	PDS-2CDL-60	—
7.0	PDS-2CDMS-70	PDS-2CDES-70	PDS-2CDS-70	—	PDS-2CDM-70	—	PDS-2CDL-70	—

Extended bur: Burs extend 10mm beyond Long type

Extra Coarse Diamond Burs



D Head Diameter	MS	Extra Short	Short	Medium	Long
	for P200-2AMS P200-2SMS	for P200-2AES P200-2SES PD-2AES PD-2SES	for P200-2AS P200-2SS PD-2AS PD-2SS	for P200-2AM P200-2SM PD-2AM PD-2SM	for P200-2AL P200-2SL PD-2AL
3.0	PDS-2ECDMS-30	PDS-2ECDES-30	PDS-2ECDS-30	PDS-2ECDM-30	PDS-2ECDL-30
4.0	PDS-2ECDMS-40	PDS-2ECDES-40	PDS-2ECDS-40	PDS-2ECDM-40	PDS-2ECDL-40
5.0	PDS-2ECDMS-50	PDS-2ECDES-50	PDS-2ECDS-50	PDS-2ECDM-50	PDS-2ECDL-50
6.0	PDS-2ECDMS-60	PDS-2ECDES-60	PDS-2ECDS-60	PDS-2ECDM-60	PDS-2ECDL-60
7.0	PDS-2ECDMS-70	—	—	—	—

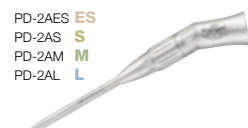
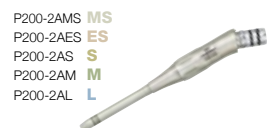

ROTARY INSTRUMENTS $\varnothing 2.35\text{mm}$

Neuro Burs



D Head Diameter	MS	Extra Short	Short	Medium	Long
	for P200-2AMS P200-2SMS	for P200-2AES P200-2SES PD-2AES PD-2SES	for P200-2AS P200-2SS PD-2AS PD-2SS	for P200-2AM P200-2SM PD-2AM PD-2SM	for P200-2AL P200-2SL PD-2AL
1.8	PDS-2NMS-18	PDS-2NES-18	PDS-2NS-18	PDS-2NM-18	PDS-2NL-18
3.0	PDS-2NMS-30	PDS-2NES-30	PDS-2NS-30	PDS-2NM-30	PDS-2NL-30

Acorn Burs



D Head Diameter	MS	Extra Short	Short
	for P200-2AMS P200-2SMS	for P200-2AES P200-2SES PD-2AES PD-2SES	for P200-2AS P200-2SS PD-2AS PD-2SS
7.5	PDS-2AMS-75	PDS-2AES-75	PDS-2AS-75

Pear Burs



D Head Diameter	MS	Extra Short	Short
	for P200-2AMS P200-2SMS	for P200-2AES P200-2SES PD-2AES PD-2SES	for P200-2AS P200-2SS PD-2AS PD-2SS
6.0	PDS-2PMS-60	PDS-2PES-60	PDS-2PS-60

Egg Burs



D Head Diameter	MS	Extra Short	Short
	for P200-2AMS P200-2SMS	for P200-2AES P200-2SES PD-2AES PD-2SES	for P200-2AS P200-2SS PD-2AS PD-2SS
4.0	PDS-2EMS-40	PDS-2EES-40	PDS-2ES-40
6.0	PDS-2EMS-60	PDS-2EES-60	PDS-2ES-60

Barrel Burs



D Head Diameter	MS	Extra Short	Short
	for P200-2AMS P200-2SMS	for P200-2AES P200-2SES PD-2AES PD-2SES	for P200-2AS P200-2SS PD-2AS PD-2SS
4.0	PDS-2BMS-40	PDS-2BES-40	PDS-2BS-40
6.0	PDS-2BMS-60	PDS-2BES-60	PDS-2BS-60

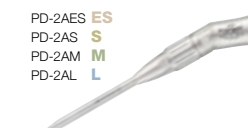

ROTARY INSTRUMENTS $\varnothing 2.35\text{mm}$

Lindemann Burs

L x D Length, Head Diameter	MS for P200-2AMS P200-2SMS	Extra Short for P200-2AES P200-2SES PD-2AES PD-2SES	Short for P200-2AS P200-2SS PD-2AS PD-2SS
11 x 2.1	PDS-2LMS-11	PDS-2LES-11	PDS-2LS-11
26 x 2.3	PDS-2LMS-26	PDS-2LES-26	PDS-2LS-26

Wirepass Drills

D Head Diameter	MS for P200-2AMS P200-2SMS	Extra Short for P200-2AES P200-2SES PD-2AES PD-2SES	Short for P200-2AS P200-2SS PD-2AS PD-2SS
1.0	PDS-2WMS-10	PDS-2WES-10	PDS-2WS-10
1.2	PDS-2WMS-12	PDS-2WES-12	PDS-2WS-12
1.5	PDS-2WMS-15	PDS-2WES-15	PDS-2WS-15

ROTARY INSTRUMENTS $\varnothing 2.35\text{mm}$

Twist Drill Flat Tail

D Head Diameter	for P200-2SD PD-2SD PD-2AD
1.5	PDS-2TD-15
2.0	PDS-2TD-20

Fissure Burs

D Head Diameter	MS for P200-2AMS P200-2SMS	Extra Short for P200-2AES P200-2SES PD-2AES PD-2SES	Short for P200-2AS P200-2SS PD-2AS PD-2SS
1.2	PDS-2FMS-12	PDS-2FES-12	PDS-2FS-12
1.6	PDS-2FMS-16	PDS-2FES-16	PDS-2FS-16
2.1	PDS-2FMS-21	PDS-2FES-21	PDS-2FS-21

ROTARY INSTRUMENTS $\varnothing 3.17\text{mm}$

Craniotome Handpiece Burs

Pediatric	Medium	Long
for P200-CRD-P PD-CRD-P	for P200-CRD-M PD-CRD-M	for P200-CRD-L PD-CRD-L
PDS-CRA-P	PDS-CRA-M	PDS-CRA-L

Router Burs

Pediatric	Medium	Long
for P200-CRD-P PD-CRD-P	for P200-CRD-M PD-CRD-M	for P200-CRD-L PD-CRD-L
PDS-ROU-P	PDS-ROU-M	PDS-ROU-L



ROTARY INSTRUMENTS $\varnothing 3.17\text{mm}$

Round Fluted Burs

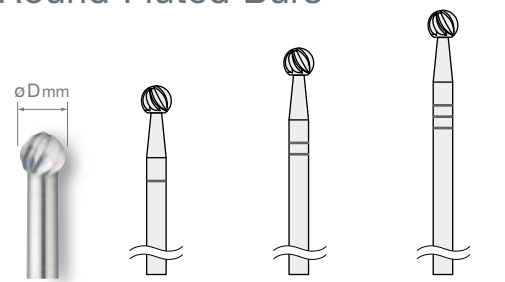

D Head Diameter	Short	Medium	Long
	for P200-3GAS	for P200-3GAM	for P200-3GAL
1.0	PDS-3CS-10	PDS-3CM-10	—
2.0	PDS-3CS-20	PDS-3CM-20	PDS-3CL-20
3.0	PDS-3CS-30	PDS-3CM-30	PDS-3CL-30
4.0	PDS-3CS-40	PDS-3CM-40	PDS-3CL-40
5.0	PDS-3CS-50	PDS-3CM-50	PDS-3CL-50
6.0	PDS-3CS-60	PDS-3CM-60	PDS-3CL-60
7.0	PDS-3CS-70	PDS-3CM-70	PDS-3CL-70

Diamond Burs

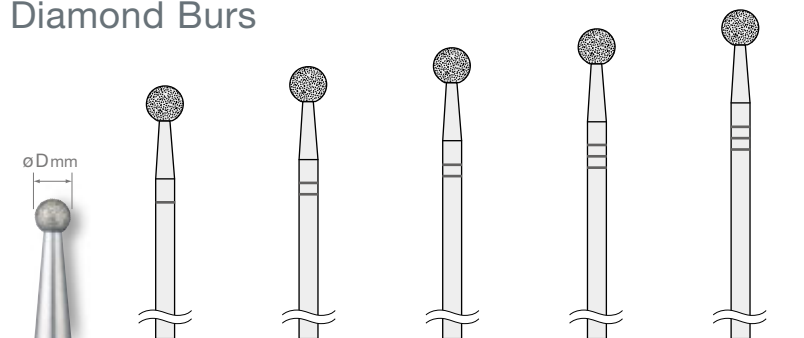

D Head Diameter	Short	Medium	Medium [Extended]	Long	Long [Extended]
	for P200-3GAS	for P200-3GAM	for P200-3GAM	for P200-3GAL	for P200-3GAL
1.0	PDS-3DS-10	PDS-3DM-10	—	—	—
2.0	PDS-3DS-20	PDS-3DM-20	PDS-3DM-20E	PDS-3DL-20	PDS-3DL-20E
3.0	PDS-3DS-30	PDS-3DM-30	—	PDS-3DL-30	—
4.0	PDS-3DS-40	PDS-3DM-40	—	PDS-3DL-40	—
5.0	PDS-3DS-50	PDS-3DM-50	—	PDS-3DL-50	—
6.0	PDS-3DS-60	PDS-3DM-60	—	PDS-3DL-60	—
7.0	PDS-3DS-70	PDS-3DM-70	—	PDS-3DL-70	—

Extended bur: Burs extend 10mm beyond Long type



ROTARY INSTRUMENTS $\varnothing 3.17\text{mm}$

Coarse Diamond Burs

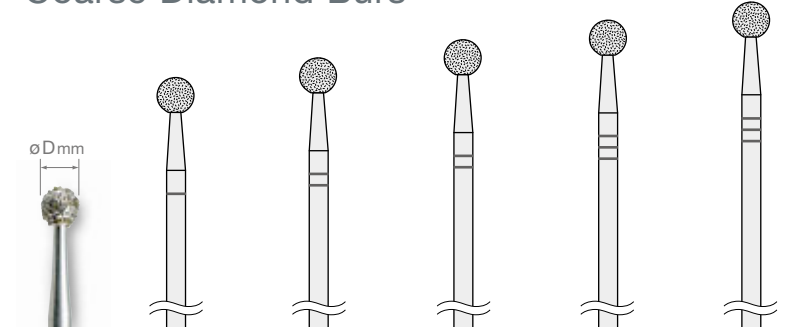

D Head Diameter	Short	Medium	Medium [Extended]	Long	Long [Extended]
	for P200-3GAS	for P200-3GAM	for P200-3GAM	for P200-3GAL	for P200-3GAL
3.0	PDS-3CDS-30	PDS-3CDM-30	PDS-3CDM-30E	PDS-3CDL-30	PDS-3CDL-30E
4.0	PDS-3CDS-40	PDS-3CDM-40	PDS-3CDM-40E	PDS-3CDL-40	PDS-3CDL-40E
5.0	PDS-3CDS-50	PDS-3CDM-50	PDS-3CDM-50E	PDS-3CDL-50	PDS-3CDL-50E
6.0	PDS-3CDS-60	PDS-3CDM-60	—	PDS-3CDL-60	—
7.0	PDS-3CDS-70	PDS-3CDM-70	—	PDS-3CDL-70	—

Extended bur: Burs extend 10mm beyond Long type

Acorn Burs

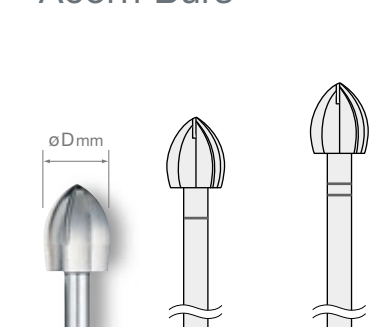

D Head Diameter	Short	Medium
	for P200-3GAS	for P200-3GAM
7.5	PDS-3AS-75	PDS-3AM-75
9.0	PDS-3AS-90	PDS-3AM-90

Neuro Burs

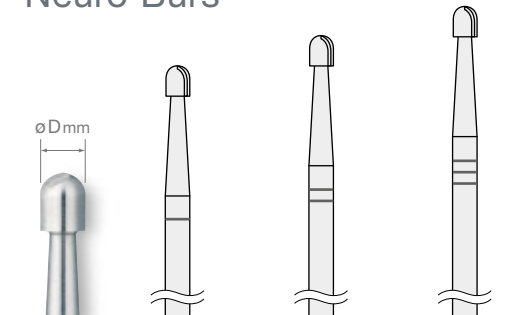

D Head Diameter	Short	Medium	Long
	for P200-3GAS	for P200-3GAM	for P200-3GAL
1.8	PDS-3NS-18	PDS-3NM-18	PDS-3NL-18
3.0	PDS-3NS-30	PDS-3NM-30	PDS-3NL-30

Cylinder Burs

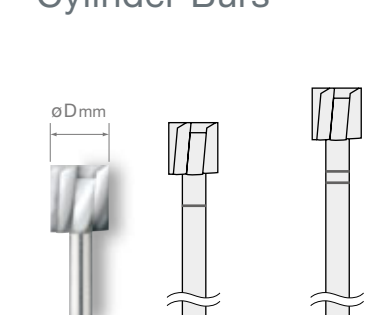

D Head Diameter	Short	Medium
	for P200-3GAS	for P200-3GAM
6.0	PDS-3BS-60	PDS-3BM-60
9.1	PDS-3BS-91	PDS-3BM-91



SAW BLADES

Sagittal and Oscillating Saw Blades

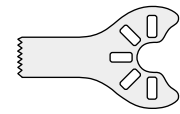

order code **PDS-SO-411**

- Depth : 11.5 mm
- Width : 5.5 mm
- Thickness : 0.4 mm

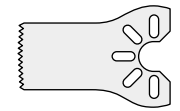

order code **PDS-SO-412**

- Depth : 11.5 mm
- Width : 9.0 mm
- Thickness : 0.4 mm

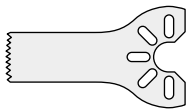

order code **PDS-SO-422**

- Depth : 15.0 mm
- Width : 7.0 mm
- Thickness : 0.4 mm

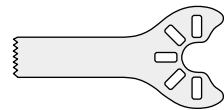

order code **PDS-SO-431**

- Depth : 18.0 mm
- Width : 5.5 mm
- Thickness : 0.4 mm

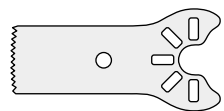

order code **PDS-SO-432**

- Depth : 18.0 mm
- Width : 9.0 mm
- Thickness : 0.4 mm

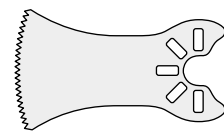

order code **PDS-SO-433**

- Depth : 18.5 mm
- Width : 16.5 mm
- Thickness : 0.4 mm

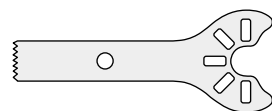

order code **PDS-SO-441**

- Depth : 25.0 mm
- Width : 5.5 mm
- Thickness : 0.4 mm



order code **PDS-SO-442**

- Depth : 25.0 mm
- Width : 9.3 mm
- Thickness : 0.4 mm

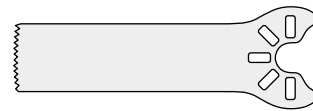

order code **PDS-SO-452**

- Depth : 31.0 mm
- Width : 9.0 mm
- Thickness : 0.4 mm

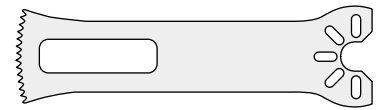

order code **PDS-SO-453**

- Depth : 39.0 mm
- Width : 13.2 mm
- Thickness : 0.4 mm

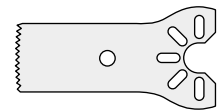

order code **PDS-SO-632**

- Depth : 18.0 mm
- Width : 9.0 mm
- Thickness : 0.6 mm

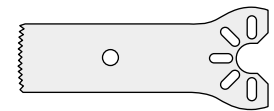

order code **PDS-SO-642**

- Depth : 25.0 mm
- Width : 9.3 mm
- Thickness : 0.6 mm

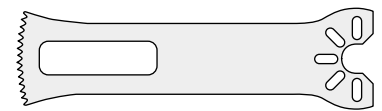

order code **PDS-SO-653**

- Depth : 39.0 mm
- Width : 13.2 mm
- Thickness : 0.6 mm



INTRA ORAL BLADES

Oscillating Saw Blades (for Intra Oral)

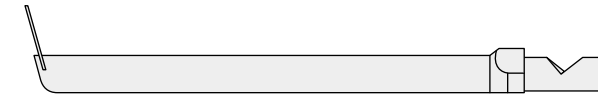

order code **PDS-OSC-422**

- Depth : 7.0 mm
- Width : 11.5 mm
- Thickness : 0.4 mm

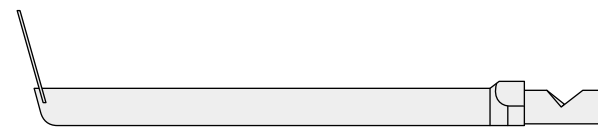

order code **PDS-OSC-432**

- Depth : 12.0 mm
- Width : 11.5 mm
- Thickness : 0.4 mm



Adaptor

order code **PD-OSC-A**

- For Oscillating Intra Oral Blades
- Bundled Item: Corresponding wrench (1), and screws (2)

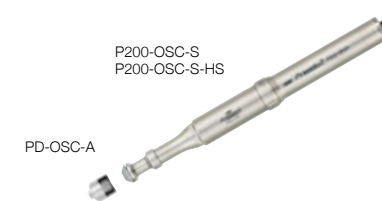

SAW BLADES

Lâminas Serras para Reciprocante

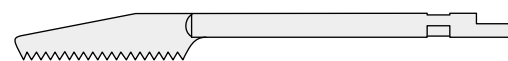

Cod. PDS-RE-4023

- Comp. da Lâmina : 23.4 mm
- Espessura : 0.38 mm

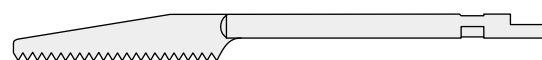

Cod. PDS-RE-4028

- Comp. da Lâmina : 28.0 mm
- Espessura : 0.38 mm

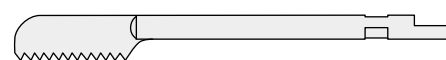

Cod. PDS-RE-4114

- Comp. da Lâmina : 14.5 mm
- Espessura : 0.4 mm



Cod. PDS-RE-4127

- Comp. da Lâmina : 27.0 mm
- Espessura : 0.4 mm



Cod. PDS-RE-4217

- Comp. da Lâmina : 17.5 mm
- Espessura : 0.4 mm

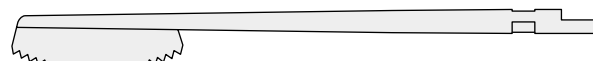

Cod. PDS-RE-4223

- Comp. da Lâmina : 23.0 mm
- Espessura : 0.4 mm

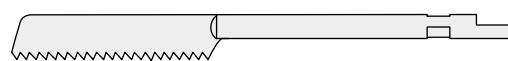

Cod. PDS-RE-6127

- Comp. da Lâmina : 27.0 mm
- Espessura : 0.6 mm

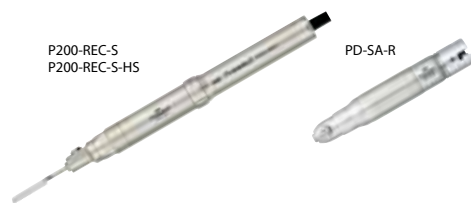

P200-REC-S
P200-REC-S-HS

PD-SA-R



RASPS

Lâminas Serras para Reciprocante Raspadora

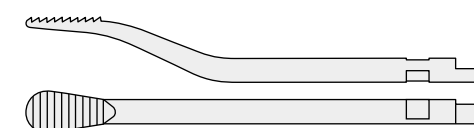

Cod. PDS-RE-R011

- Comp. da Lâmina : 11.0 mm
- Espessura : 5.5 mm

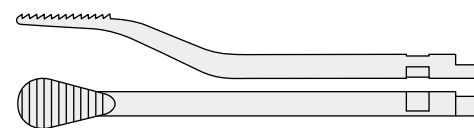

Cod. PDS-RE-R012

- Comp. da Lâmina : 13.0 mm
- Espessura : 7.0 mm

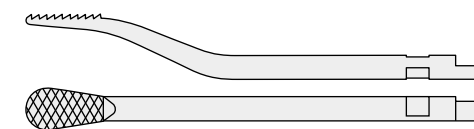

Cod. PDS-RE-R111

- Comp. da Lâmina : 11.0 mm
- Espessura : 5.3 mm

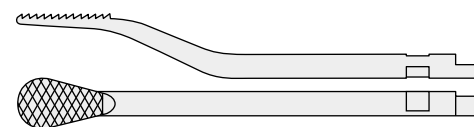

Cod. PDS-RE-R112

- Comp. da Lâmina : 13.0 mm
- Espessura : 7.0 mm



P200-REC-S
P200-REC-S-HS

PD-SA-R





The Company



Global Quality comes from NSK's manufacturing method

Providing durable and elegant, yet competitively priced products has been NSK's philosophy since it was established. NSK consistently provides quality products that deliver high levels of customer satisfaction. We achieve this by reflecting market needs in the development process in a timely way based on our core technology of ultra high-speed rotation. Our customer-oriented approach is supported by in-house production of over 85% of parts, and integrated services from development and manufacturing to sales. Rapid product development, flexible production systems, and global sales network combine organically to create a structure under which our philosophy has been maintained constantly. Our products for dental and surgical applications support front-line medical institutions and individual health care.

Moreover, our general industrial products, such as industrial equipment for precision molding and abrasive finishing, contribute to providing convenience and choice in people's lives. We always think how our products can satisfy and impress our customers. NSK's employees work constantly to create new value, while adhering to our core philosophy. Their pride and enthusiasm are backed up by superior technologies and state-of-the-art equipment. As a group of professionals, with each member possessing advanced skills and technical knowledge, they deliver comprehensive products and services that satisfy and impress customers. And, as a group, they are the driving force behind improving value and developing unique products.



CNC processing machine – NSK State of the art computer controlled equipment manufactures precision parts 24 hours a day.



NC lathe process – Even during computer-controlled production, the automated process is monitored by a skilled operator to ensure the highest quality of micro precision production.



State-of-the-art factory was built in 2005 to expand production capacity.

Response to environmental issues is one of the important qualities of product

At a time when environmental problems are significant global issues, a corporate approach to reducing environmental loads can affect evaluations of the quality of management, and in turn, products themselves. NSK has developed measures to reduce environmental load, as a company manufacturing medical instruments, which are closely related to human health. Not only has NSK obtained ISO 14001 certification in 1999, but it also promotes improvement activities with a corporate-wide system for reducing environmental load. We have completely abolished the use of environmental load chemicals such as chlorofluorocarbons, and achieved an impressive recycling rate of 97% for cutting oil, a large amount of which is used for metal cutting in factories, by introducing a complete recycling system.

Furthermore, we focus on the production of environmentally friendly products from the initial stage of design and development, making every effort to offer ecological products, such as by adopting green materials, ensuring compliance with the "RoHS directive", producing durable products, and energy efficient design. NSK will continue improvement activities to ensure a sustainable environment.



Wasted production oil is 97% recycled after being purified via special filtration equipment.



Wastewater from the factory, thoroughly cleaned by a purifier, is passed through a carp pond and released into the river.

Technological development is born in the experience

We think ideas for innovative engineering developments can always be found at the places where products are used, and by requests from users. NSK sets themes for new product development by referring to valuable information from end-users in various fields – such as dentists, surgeons, and production engineers – making best use of our global sales network. NSK has established an integrated system to complete all development processes internally, aiming at shorter lead-times and timely delivery to customers. One recent trend has been for products that integrate mechanics and electronics, and NSK has a group of engineers who can respond promptly to market needs. NSK has also various state-of-the-art test facilities for promoting timely research and development. For instance, the "Electro Magnetic Compatibility (EMC) standard", which is stricter than that for general household appliances, is applied to medical instruments. NSK has in-house EMC test facilities, which make major contributions to shortening development periods.

Our most important mission is to consistently introduce useful new products to the world with the pride of a manufacturer.



Electromagnetic wave measuring facility – Measuring electromagnetic waves radiated from products