

Primado2



NSK

NSK The Company

To us, KANUMA is the center of the world.

It was here in Kanuma that we first started and it is here where we will continue to create the best in class, high-speed rotation technology in the world. "Made in Japan" symbolizes world class quality and craftsmanship and now "Made in Kanuma" will define the finest quality in high-speed drills across the world.



Quality Results from Processes

This has been the NSK policy since its foundation. Up to 30 processes may be necessary to create one complete component from a bar of raw material. The total number of machining processes required to create all parts of a single product is 930. If the individual processes do not attain the degree of accuracy needed, the final product will not deliver the requisite high precision. Ensuring micron-scale accuracy is crucial. In pursuit of such accuracy, NSK's key strength lies in the ability to internally manage integrated production from the component stage. To ensure high quality, defective parts are never passed. Manufacturing is a constant battle to push the limits. And the state-of-the-art manufacturing pursued by NSK is an never-ending challenge.



Global Network

NSK has sales subsidiaries in 15 countries with each subsidiary actively conducting sales and marketing activities in its local territory, providing detailed after-sales services and attracting new NSK fans every day. Furthermore, NSK is also collaborating with import agents in other countries and building strong ties to promote sales in local areas. NSK has built a solid global sales network and exports to 135 countries. The voice of our sales partners is important, and NSK strives to ensure quick and reliable support. These strong partnerships can then transfer to our customers, who can be fully confident in our brand and products.



Feel The Difference

Stable Rotation

- Primado2 provides smooth acceleration at low speeds and stable rotation at middle/high speeds
- Less run-out delivers precise, smooth bone cutting performance

Uncompromising Design

- Variable exposure allows for versatility of surgical procedures *P300 Attachment
- High quality cutting accessories made with innovative technology

Better Usability

- The universal bur length system features one bur shank length that can be used with any length attachment *Standard Attachment 300
- The risk of excessive heat development and consequent malfunction as a result of insufficient cleaning is reduced





Product Lineup

Control Unit



Primado2 Control Unit

Foot Control

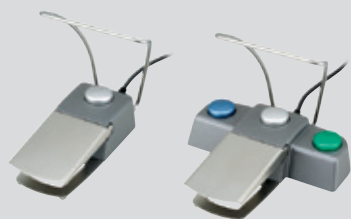

Primado2 Foot Control

Reprocessing



Cleaning Tool



PANA SPRAY Plus

Slim Motor Series



Primado2 Slim Motor

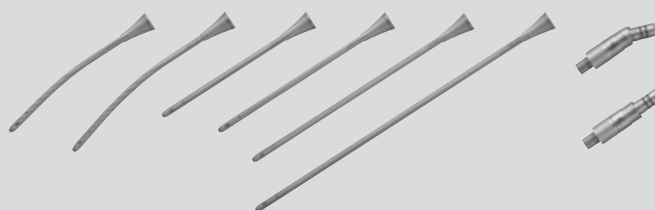

Slim Attachment 300



Super Slim Handpiece 200

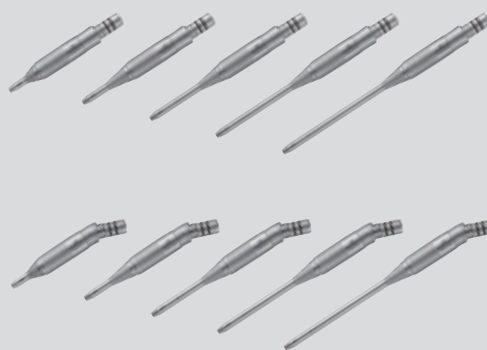

Standard Attachment 300



Perforator

Drill

Craniotome



Contra Angle

Metal Cutting

High Torque Motor Series



Primado2 High Torque Motor



High Speed Handpiece 200

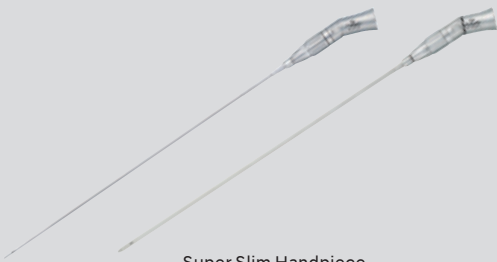

Super Slim Handpiece



Standard Handpiece



Perforator



Drill



Craniotome



Contra Angle

Micro Bone Saw Motor Series



Primado2 Micro Bone Saw Motor



Reciprocating Saw Attachment



Sagittal Saw Attachment

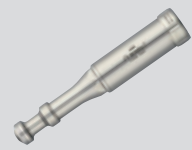

Oscillating Saw Attachment

Wire Pin Driver Series



Primado2 Wire Pin Driver

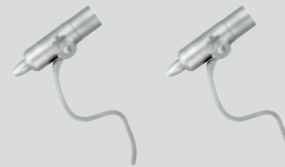

Wire & Pin Collet



Drill Attachment



Reamer Attachment



Saw Attachment

Primado2 Control Unit

Compact design for easy set-up

Extensive options can be set up individually (e.g., Acceleration/Brake adjustment, Irrigation, etc.)

Main panel's simple operation makes it user-friendly



Order Code
P200-CU-120
Primado2 Control Unit 120V

Order Code
P200-CU-230
Primado2 Control Unit 230V

- Power Supply : AC120V / 230V 50/60 Hz
- Dimension : W278 x D268 x H160 (mm)
- Weight : 6.9 kg

HOME Screen

- Speed control
- Irrigation control
- Reverse rotation control
- Priming control
- Foot Control setting displayed

Setting Options

[Control Unit]

- Brightness
- Volume
- Language settings (6 languages available)
- Displays rotation speed of engaged motor/attachment

[Motor]

- Acceleration adjustment
- Brake adjustment
- Torque adjustment
- Oscillation adjustment (available for Wire Pin Driver only)

Configuration Settings

Automatic motor recognition

Integrated High Performance Irrigation Pump



Foot Control

Available in two models: single function button and multi-function button

An open pedal design enables precise and easy control

Each button can be set to a specific function to meet the operator's preference



Order Code

FC-73

Primado2 Single Foot Control

• 1 pedal with 1 function button



Order Code

FC-74

Primado2 Multi Foot Control

• 1 pedal with 3 function buttons

Functional Options

- Foot control ON/OFF
- A↔B control (switching between motors)
- Speed control
(adjust rotational speed; Min. 30%⇒default⇒ Max. 100%)
- Reverse rotation mode
- Irrigation ON/OFF
- Flush (continuous 100% irrigation when pressed)
- Disable (i.e., set the status as no function)
- Speed control : variable
- IP rating : IPX8



Slim Motor Series

- | Compact and lightweight design prevents surgeon fatigue during procedures
- | A variety of attachments are available
- | Quick Joint allows for an easy attachment-motor connection



Primado2 Slim Motor

- Speed : Max. 80,000 min⁻¹
- Bundled Item : P200-EZ-SM (see p.30)



Order Code
P200-SMH-S
Primado2 Slim Motor Short

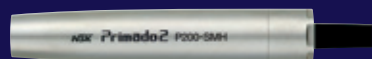

Order Code
P200-SMH
Primado2 Slim Motor

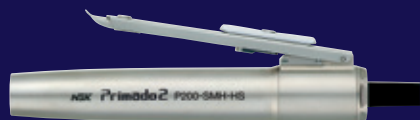

Order Code
P200-SMH-HS
Primado2 Slim Motor/HS
• Hand Control type

P300 Attachment Key Features



The stable rotation performance is consistent with current P200 attachments, however, the P300 attachments are designed to improve visibility, smooth operation, and safety.

Variable Exposure

- Improved accessibility and visibility due to the 6-step adjustment mechanism

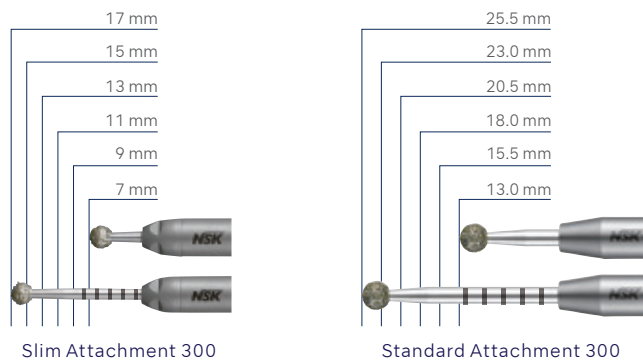

- The attachment's twist collet allows for variable exposure without having to handle the bur. *Standard Attachment 300

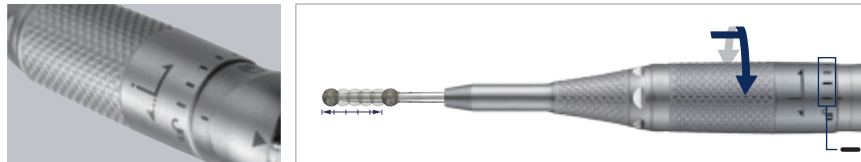

Universal Bur Length System *Standard Attachment 300

- One bur size fits all lengths of attachment
- Easier management in the operating room

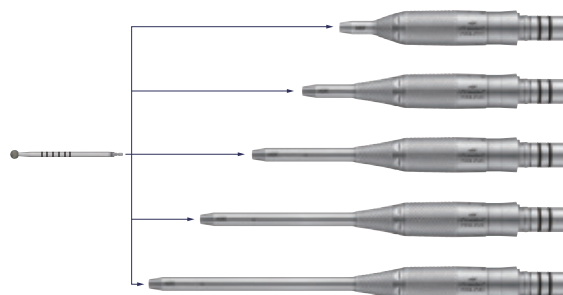

Slim Attachment 300 80,000min⁻¹

Slim Attachment Hub



Order Code
P300-1AHS
Slim Attachment Hub/Straight



Order Code
P300-1AHA
Slim Attachment Hub/Angled

Tube

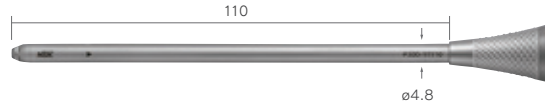

Order Code
P300-1T110
Slim Tube 110



Order Code
P300-1T110-C
Slim Tube 110/C

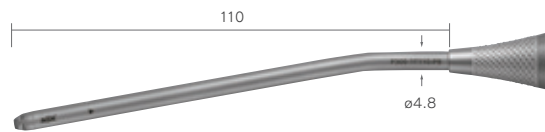

Order Code
P300-1T110-PB
Slim Tube 110/PB

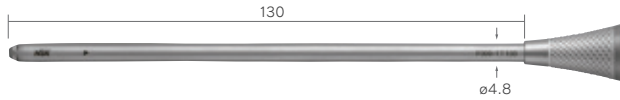

Order Code
P300-1T130
Slim Tube 130

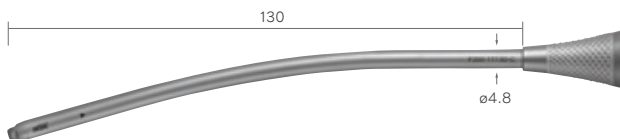

Order Code
P300-1T130-C
Slim Tube 130/C

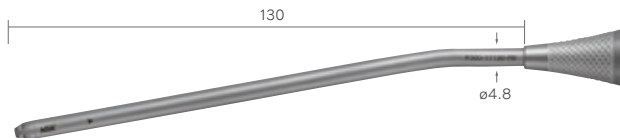

Order Code
P300-1T130-PB
Slim Tube 130/PB

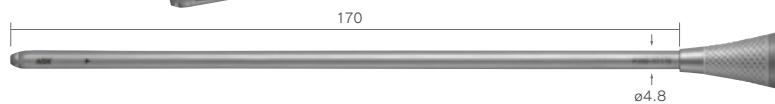

Order Code
P300-1T170
Slim Tube 170

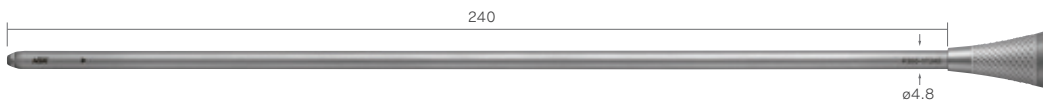

Order Code
P300-1T240
Slim Tube 240

Accessory



Order Code
P300-1T-B
Slim Tube Beak



Order Code
P300-1T-H
Slim Tube Hood

*Cannot be used with the Irrigation Nozzle.

Irrigation Nozzle

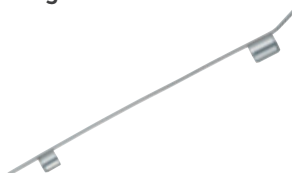



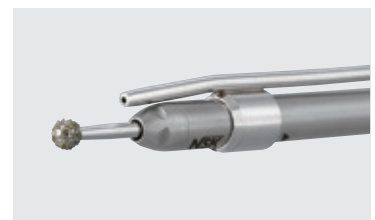

Order Code
P200-IN-1A155
For P300-1T110 / P300-1T110-C / P300-1T110-PB

Order Code
P200-IN-1A175
For P300-1T130 / P300-1T130-C / P300-1T130-PB





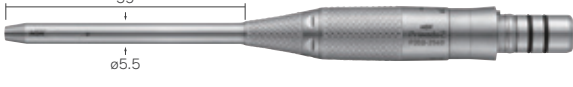

Standard Attachment 300 80,000min⁻¹

Straight

	Order Code P300-2S10 STD Attachment 10/Straight
	Order Code P300-2S20 STD Attachment 20/Straight
	Order Code P300-2S40 STD Attachment 40/Straight
	Order Code P300-2S60 STD Attachment 60/Straight
	Order Code P300-2S80 STD Attachment 80/Straight

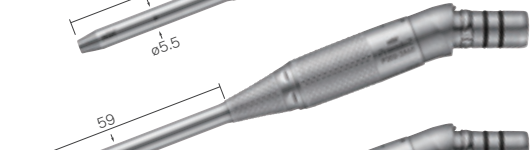
Angled

	Order Code P300-2A10 STD Attachment 10/Angled
	Order Code P300-2A20 STD Attachment 20/Angled
	Order Code P300-2A40 STD Attachment 40/Angled
	Order Code P300-2A60 STD Attachment 60/Angled
	Order Code P300-2A80 STD Attachment 80/Angled

Accessory



Order Code
P300-2-B
STD Attachment Beak



*Cannot be used with the Irrigation Nozzle.

Irrigation Nozzle



Order Code
PD-IN-D
For P300-2S10 / P300-2A10
P300-2S20 / P300-2A20

Order Code
PD-IN-2ES
For P300-2S40 / P300-2A40

Order Code
PD-IN-2S
For P300-2S60 / P300-2A60

Order Code
PD-IN-2M
For P300-2S80 / P300-2A80

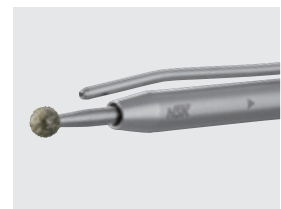

Slim Handpiece 200 80,000min⁻¹

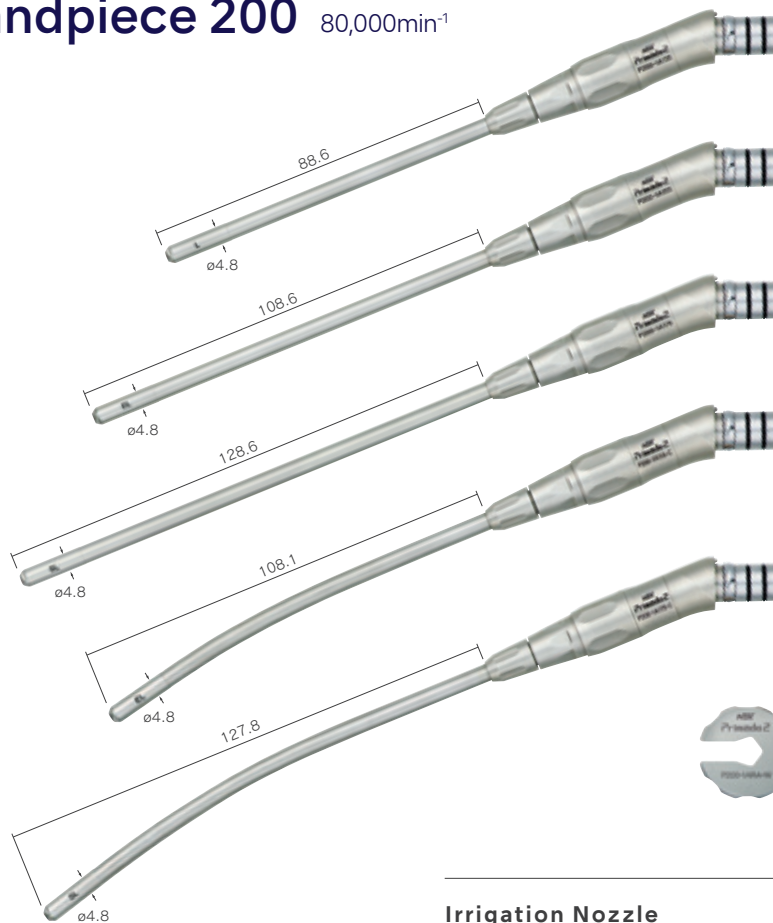

Order Code
P200-1A135
Slim Handpiece200 L

Order Code
P200-1A155
Slim Handpiece200 EL

Order Code
P200-1A175
Slim Handpiece200 SL

Order Code
P200-1A155-C
Slim Handpiece200 EL/Curved

Order Code
P200-1A175-C
Slim Handpiece200 SL/Curved



Order Code
P200-1ARA-W
Wrench for Slim/Super Slim

- Corresponding wrench for bur guard
- Included with Slim Handpiece 200

Irrigation Nozzle



Order Code
P200-IN-1A155
For P200-1A155 / P200-1A155-C

Order Code
P200-IN-1A175
For P200-1A175 / P200-1A175-C

Super Slim Handpiece 200 20,000min⁻¹



Order Code
P200-RA330
Super Slim Handpiece200 SPL

Order Code
P200-RA330-L
Super Slim Handpiece200 SPL/L
• Large Bore Type







Order Code
P200-1ARA-W
Wrench for Slim/Super Slim

- Corresponding wrench for bur guard
- Included with Super Super Slim Handpiece 200

Standard Handpiece 200 80,000min⁻¹

Straight

	Order Code P200-2SMS Std. Straight Handpiece200 MS
	Order Code P200-2SES Std. Straight Handpiece200 ES
	Order Code P200-2SS Std. Straight Handpiece200 S
	Order Code P200-2SM Std. Straight Handpiece200 M
	Order Code P200-2SL Std. Straight Handpiece200 L

Angled

	Order Code P200-2AMS Std. Angled Handpiece200 MS
	Order Code P200-2AES Std. Angled Handpiece200 ES
	Order Code P200-2AS Std. Angled Handpiece200 S
	Order Code P200-2AM Std. Angled Handpiece200 M
	Order Code P200-2AL Std. Angled Handpiece200 L

Irrigation Nozzle



Order Code
PD-IN-D
For P200-2SMS (MS)
P200-2AMS (MS)

Order Code
PD-IN-2ES
For P200-2SES (ES)
P200-2AES (ES)

Order Code
PD-IN-2S
For P200-2SS (S)
P200-2AS (S)

Order Code
PD-IN-2M
For P200-2SM (M)
P200-2AM (M)

Order Code
PD-IN-2L
For P200-2SL (L)
P200-2AL (L)



Perforator Handpiece 200 $1,250\text{min}^{-1}$



Order Code

P200-PER

Perforator Handpiece200

• Compatible Chuck: Hudson Chuck

Drill Handpiece 200 $80,000\text{min}^{-1}$



Order Code

P200-2SD

Straight Drill Handpiece 200

Irrigation Nozzle



Order Code

PD-IN-D

For P200-2SD



Contra Angle Handpiece 200



Order Code

P200-CA-4

Contra Angle Handpiece200 4:1

- 4:1 Reduction (Speed: Max. $20,000\text{min}^{-1}$)
- Latch Type Chuck
- Corresponds to $\varnothing 2.35\text{mm}$ CA burs

Craniotome Handpiece 200 $80,000\text{min}^{-1}$



Order Code
P200-CRA
Craniotome Handpiece200



Order Code
P200-CRD-P
Pediatric Duraguard200



Order Code
P200-RCRD-P
Rotatable Duraguard200 P



Order Code
P200-CRD-M
Medium Duraguard200



Order Code
P200-RCRD-M
Rotatable Duraguard200 M



Order Code
P200-CRD-L
Long Duraguard200



Order Code
P200-RCRD-L
Rotatable Duraguard200 L

Metal Cutting Handpiece 200 $80,000\text{min}^{-1}$



Order Code
P200-3MC
Metal Cutting Handpiece200

High Torque Motor Series

High torque motor delivers advanced cutting performance

Max. 100,000min⁻¹ is available with a High Speed Handpiece

Quick Joint allows for an easy attachment-motor connection



Primado2 High Torque Motor • Speed : Max. 60,000 min⁻¹

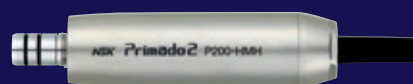

Order Code
P200-HMH
Primado2 High Torque Motor

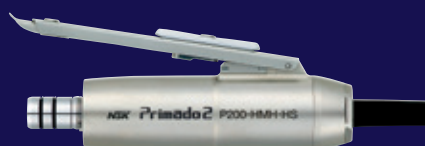

Order Code
P200-HMH-HS
Primado2 High Torque Motor/HS
• Hand Control type

High Speed Handpiece 200 100,000min⁻¹



Order Code
P200-3GAS
High Speed Handpiece200 S



Order Code
P200-3GAM
High Speed Handpiece200 M

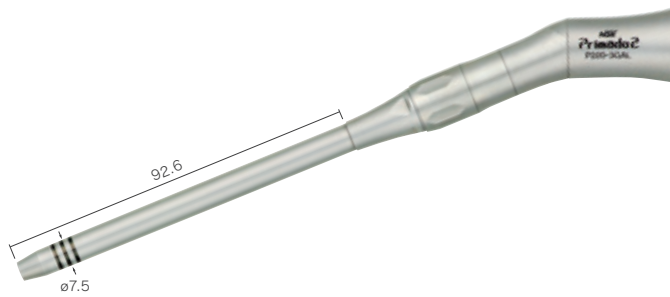

Order Code
P200-3GAL
High Speed Handpiece200 L

High Torque Motor Series

Irrigation Nozzle



Order Code
PD-IN-3S
For P200-3GAS(S)

Order Code
PD-IN-3M
For P200-3GAM(M)

Order Code
PD-IN-3L
For P200-3GAL(L)



Super Slim Handpiece 24,000min⁻¹

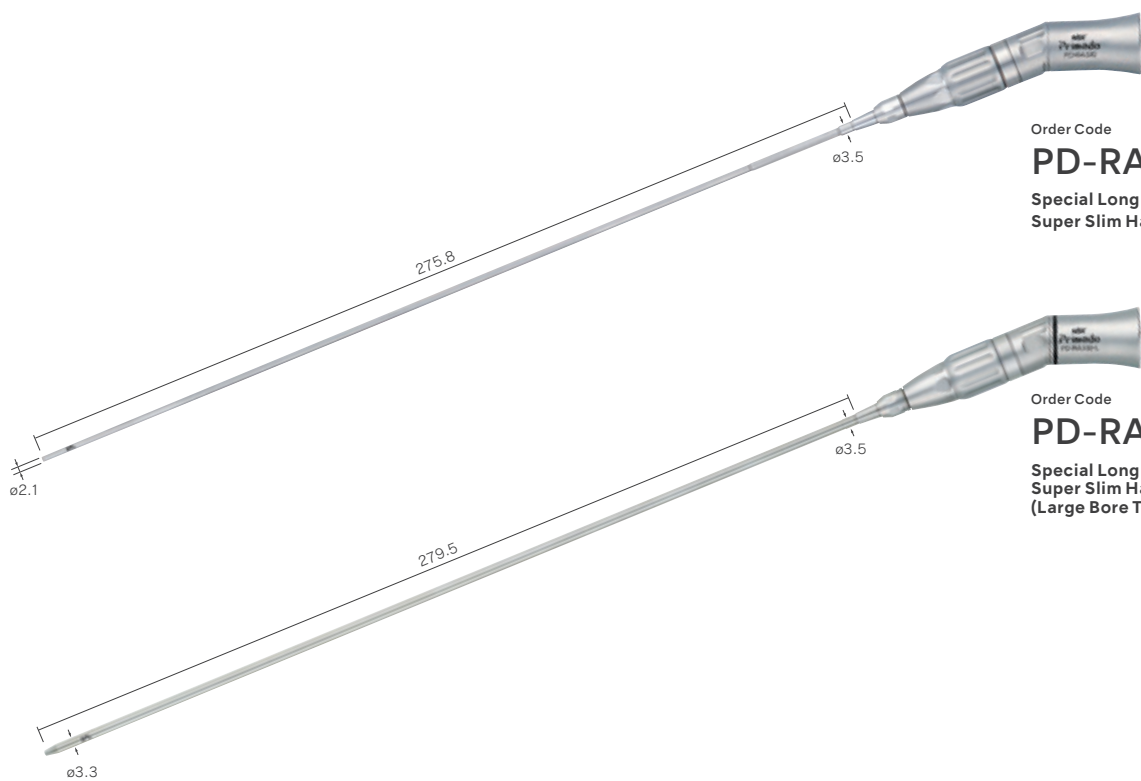

Order Code
PD-RA330
Special Long
Super Slim Handpiece

Order Code
PD-RA330-L
Special Long
Super Slim Handpiece
(Large Bore Type)

Standard Handpiece 60,000min⁻¹

Straight



Order Code
PD-2SES
Extra Short
Standard Straight Handpiece

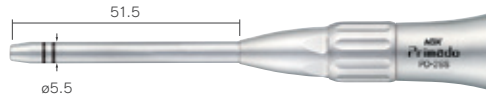

Order Code
PD-2SS
Short
Standard Straight Handpiece

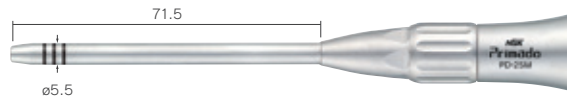

Order Code
PD-2SM
Medium
Standard Straight Handpiece

Angled

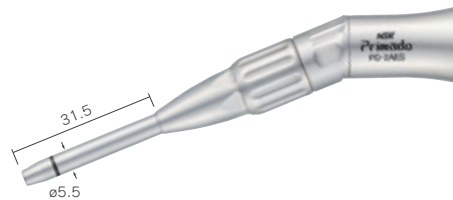

Order Code
PD-2AES
Extra Short
Standard Angle Handpiece

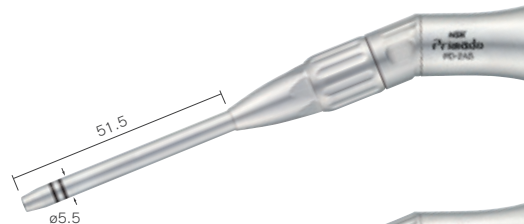

Order Code
PD-2AS
Short
Standard Angle Handpiece

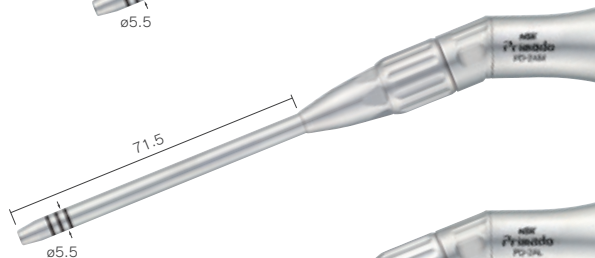

Order Code
PD-2AM
Medium
Standard Angle Handpiece

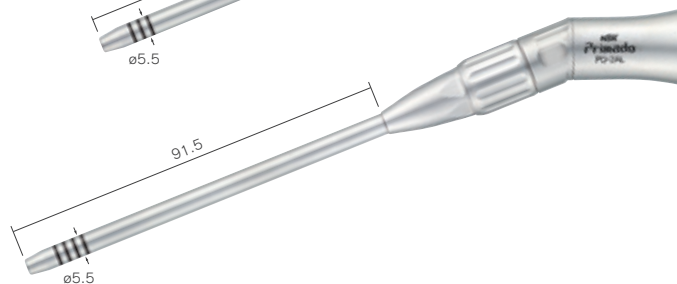

Order Code
PD-2AL
Long
Standard Angle Handpiece

Irrigation Nozzle



Order Code
PD-IN-2ES

For PD-2SES (ES)
PD-2AES (ES)

Order Code
PD-IN-2S

For PD-2SS (S)
PD-2AS (S)

Order Code
PD-IN-2M

For PD-2SM (M)
PD-2AM (M)

Order Code
PD-IN-2L

For PD-2AL (L)



Perforator Handpiece 1,200min⁻¹



Order Code

PD-PER

Perforator Handpiece

• Compatible Chuck: Hudson Chuck

Craniotome Handpiece 60,000min⁻¹



Order Code

PD-CRA

Craniotome Handpiece

• Bundled Item : PD-CRD-M

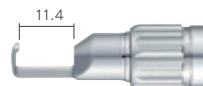

Order Code

PD-CRD-P

Duraguard Short

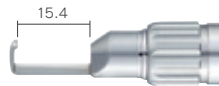

Order Code

PD-CRD-M

Duraguard Medium

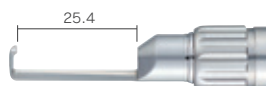

Order Code

PD-CRD-L

Duraguard Long

Drill Handpiece 60,000min⁻¹



Order Code
PD-2SD
Straight Drill Handpiece



Order Code
PD-2AD
Angled Drill Handpiece

Irrigation Nozzle



Order Code
PD-IN-D
For PD-2SD / PD-2AD



Contra Angle Handpiece



Order Code
PD-CA-16
Contra Angle Handpiece
16:1 Reduction

- 16:1 Reduction (Speed: Max. 3,750 min⁻¹)
- Latch Type Chuck
- Corresponds to ø2.35mm CA burs



Order Code
PD-CA-64
Contra Angle Handpiece
64:1 Reduction

- 64:1 Reduction (Speed: Max. 940 min⁻¹)
- Latch Type Chuck
- Corresponds to ø2.35mm CA burs

Micro Bone Saw Series

| A modular system in which one motor accepts 3 different types of saws

| Designed for powerful cutting performance and less vibration



Primado2 Micro Bone Saw Motor

- Speed : Max. 20,000 min⁻¹
- Bundled Item : P200-EZ-BM (see p.30)

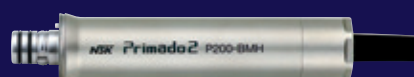

Order Code

P200-BMH

Primado2 Micro Bone Saw Motor



Order Code

P200-BMH-HS

Primado2 Micro Bone Saw Motor/HS

- Hand Control type

Reciprocating Saw 20,000min⁻¹



Order Code

P200-REC

Primado2 Rec. Attachment

- Stroke Length : 2.5mm

Order Code

P200-REC-S

Primado2 Rec. Handpiece

- Included Item : P200-BMH, P200-REC

Order Code

P200-REC-S-HS

Primado2 Rec. Handpiece/HS

- Hand Control type
- Included Item : P200-BMH-HS, P200-REC

Sagittal Saw 20,000min⁻¹



Order Code

P200-SAG

Primado2 Sag. Attachment

- Angle of Oscillation : 8°

Order Code

P200-SAG-S

Primado2 Sag. Handpiece

- Included Item : P200-BMH, P200-SAG

Order Code

P200-SAG-S-HS

Primado2 Sag. Handpiece/HS

- Hand Control type
- Included Item : P200-BMH-HS, P200-SAG

Oscillating Saw 20,000min⁻¹



Order Code

P200-OSC

Primado2 Osc. Attachment

- Angle of Oscillation : 8°

Order Code

P200-OSC-S

Primado2 Osc. Handpiece

- Included Item : P200-BMH, P200-OSC

Order Code

P200-OSC-S-HS

Primado2 Osc. Handpiece/HS

- Hand Control type
- Included Item : P200-BMH-HS, P200-OSC



Order Code

PD-OSC-A

Adaptor For Oscillating Saw

- Corresponding wrench (1), and screws (2)

**Irrigation Nozzle
for Bone Saw**



Order Code

P200-IN-BS

**For P200-REC / P200-SAG
P200-OSC**

Wire Pin Driver Series

Delivers power performance across a variety of surgical applications

The versatile options include a Drill, Reamer, and Micro Bone Saw



Primado2 Wire Pin Driver

- Speed : Max. 1,200 min⁻¹
- Rotation Mode : Forward, Reverse, Oscillating
- Bundled Item : P200-EZ-WPD (see p.30)



Order Code

P200-WPD

Primado2 Wire Pin Driver

Wire & Pin Collet 1,200min⁻¹



Order Code
PD-DA-W
Primado Wire Collet
• ø0.6~ø1.9 mm



Order Code
PD-DA-P
Primado Pin Collet
• ø2.0~ø3.2 mm

Drill Attachment 1,200min⁻¹



Order Code
PD-DA-J4
Jacobs Keyed Drill Chuck
4.0mm
• ø0.5~ø4.0 mm
• Bundled Item: T wrench

Order Code
PD-TW-J4
T-Wrench for J4 



Order Code
PD-DA-J6
Jacobs Keyed Drill Chuck
6.5mm
• ø0.5~ø6.5 mm
• Bundled Item: T wrench

Order Code
PD-TW-J6
T-Wrench for J6 



Order Code
PD-DA-A
AO Drill Chuck



Order Code
PD-DA-K
Keyless Drill Chuck
• ø0.6~ø7.4 mm

Reamer Attachment 300min⁻¹



Order Code
PD-RA-M
Hudson Modified
Trinkle Reamer



Order Code
PD-RA-H
Hudson Reamer



Order Code
PD-RA-T
Trinkle Reamer



Order Code
PD-RA-A
AO Reamer

Saw Attachment 12,000min⁻¹

Order Code
PD-SA-R
Reciprocating Saw Attachment



Order Code
PD-SA-S
Sagittal Saw Attachment



Accessories

Cleaning Tool

The risk of excessive heat development and consequent malfunction as a result of insufficient cleaning is reduced



Manual cleaning



Washer disinfectant



Order Code
PD-CTH
Cleaning Holder
• Bundled Item : PD-CTTU-606501
PD-CTTU-600504



Order Code
PD-CTAD-G
Cleaning Adaptor G
• For drying



Order Code
PD-CTAD-SM
Cleaning Adaptor SM
For Slim Motor Series each attachment



Order Code
PD-CTAD-LM
Cleaning Adaptor Luer M



Order Code
PD-CTAD-1T
Cleaning Adaptor 1T
For Slim Tube



Order Code
PD-CTAD-LF
Cleaning Adaptor Luer F



Order Code
PD-CTAD-HM
Cleaning Adaptor HM
For High Torque Motor Series each attachment



Order Code
PD-CTTU-606501
Cleaning Tube 6.0/L650



Order Code
PD-CTAD-WPD
Cleaning Adaptor WPD
For Wire Pin Driver Series each attachment



Order Code
PD-CTTU-600504
Cleaning Tube 6.0/L50 (4pcs)



Order Code
PD-CTAD-IN
Cleaning Adaptor IN
For Irrigation Nozzle
• Bundled Item : PD-CTTU-150252



Order Code
PD-CTTU-150252
Cleaning Tube 1.5/L25 (2pcs)

For automated cleaning

For manual cleaning

For drying

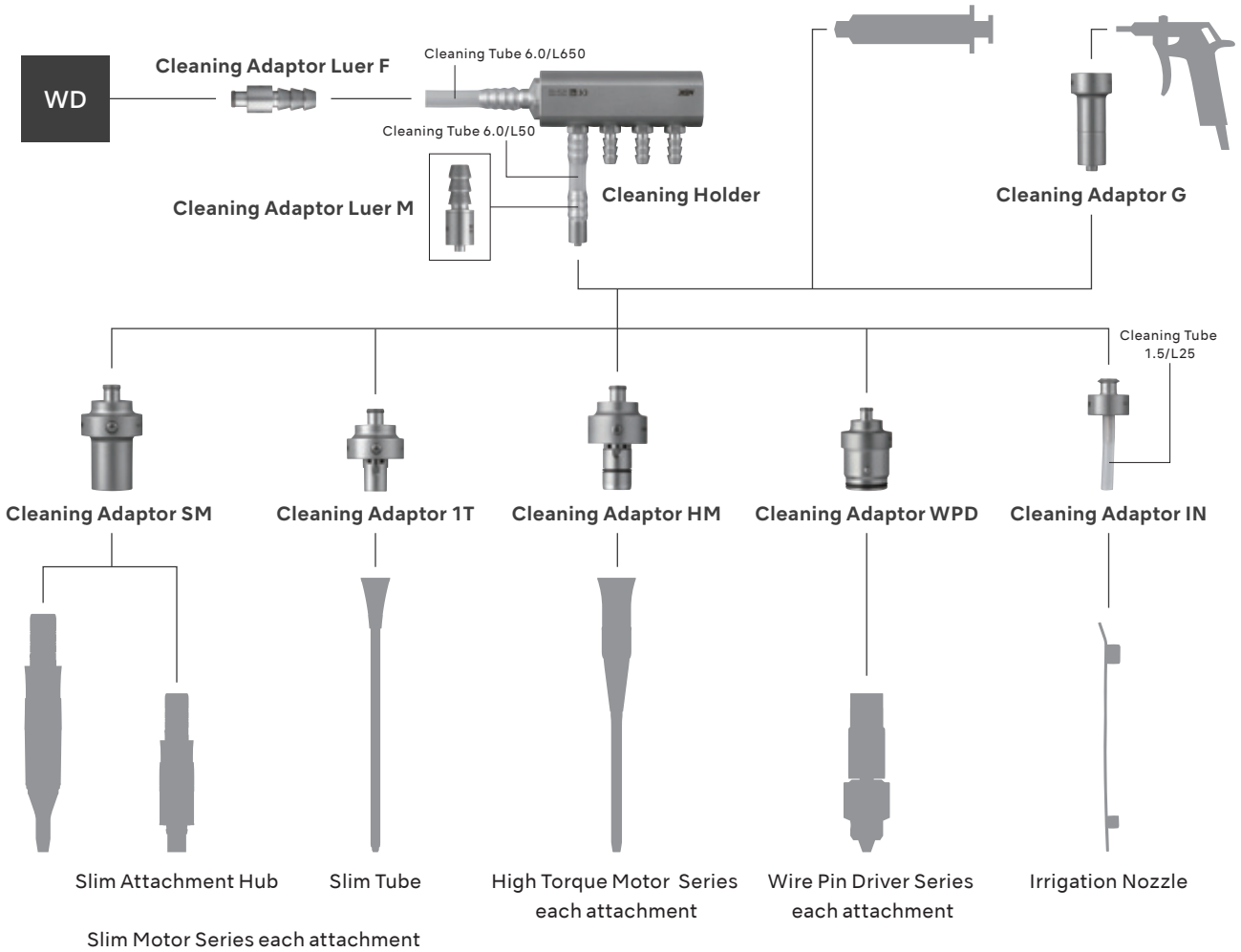

*Please be sure to read the reprocessing manual.

*These Cleaning Tools can not be used with the Bone Saw Attachment.

Sterilization Case



Order Code
SC-ML
Sterilization Metal Lid



Order Code
SC-T-F
Sterilization Tray/Free
• Dimensions : W480 x D250 x H60 (mm)

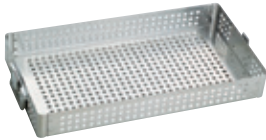

Order Code
SC-C-H70
Sterilization Case/H70
• Dimensions : W512 x D262 x H70 (mm)
• Single level case

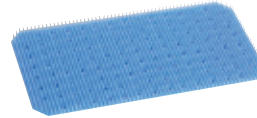

Order Code
SC-SM
Silicone Mat
• The mat for the Sterilization Tray



Order Code
SC-C-H125
Sterilization Case/H125
• Dimensions : W512 x D262 x H125 (mm)
• Double level case

Mobile Trolley



Order Code
Z299
iCart-L Mobile Trolley
• Dimensions : W360 x D420 x H800 (mm)
• Weight : 10 kg

Irrigation Tube



Order Code
PD-IT-S
Surgical Irrigation Tube
• 10 pcs/ set (Sterilized)

Lubrication



Order code
Z182100
PANA Spray Plus
• For attachments, 480 mL

Order code
Y900630
PANA Spray Plus (6pcs)
• Pack of 6

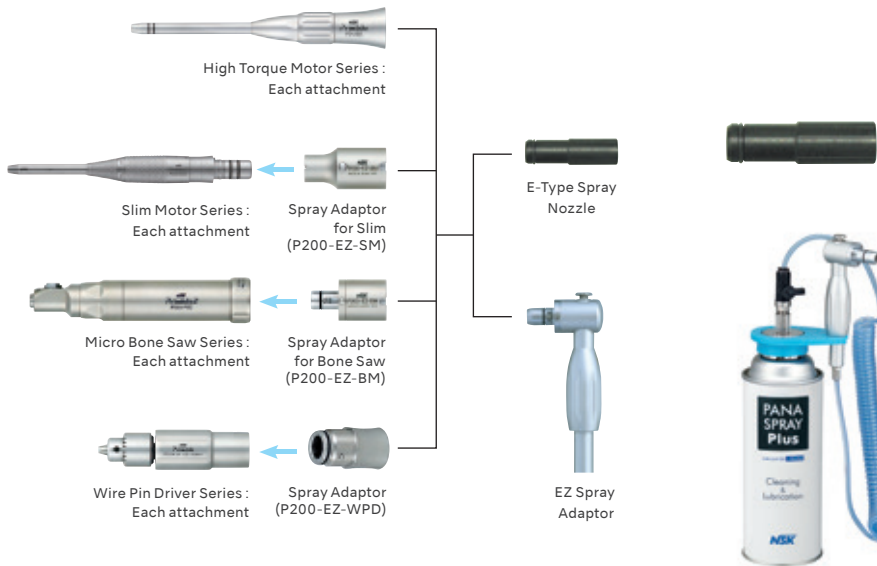

Order code
Z019090
E-Type Spray Nozzle
• For attachments

Order code
PD-EZ-M
EZ Spray Adaptor
• PANA Spray Plus is not included

Spray Mist Absorber



Order code
Y900084
Spray Mist Absorber
• Pack of 10

Index

Order Code	Page
FC-73	p.08
FC-74	p.08
P200-1A135	p.13
P200-1A155	p.13
P200-1A155-C	p.13
P200-1A175	p.13
P200-1A175-C	p.13
P200-1ARA-W	p.13
P200-2AES	p.14
P200-2AL	p.14
P200-2AM	p.14
P200-2AMS	p.14
P200-2AS	p.14
P200-2SD	p.15
P200-2SES	p.14
P200-2SL	p.14
P200-2SM	p.14
P200-2SMS	p.14
P200-2SS	p.14
P200-3GAL	p.18
P200-3GAM	p.18
P200-3GAS	p.18
P200-3MC	p.16
P200-BMH	p.23
P200-BMH-HS	p.23
P200-CA-4	p.15
P200-CRA	p.16
P200-CRD-L	p.16
P200-CRD-M	p.16
P200-CRD-P	p.16
P200-CU-120	p.07
P200-CU-230	p.07
P200-EZ-BM	p.30
P200-EZ-SM	p.30
P200-EZ-WPD	p.30
P200-HMH	p.17
P200-HMH-HS	p.17
P200-IN-1A155	p.11,13
P200-IN-1A175	p.11,13
P200-IN-BS	p.24
P200-OSC	p.24
P200-OSC-S	p.24
P200-OSC-S-HS	p.24
P200-PER	p.15
P200-RA330	p.13
P200-RA330-L	p.13
P200-RCRD-L	p.16
P200-RCRD-M	p.16
P200-RCRD-P	p.16
P200-REC	p.24

Order Code	Page
P200-REC-S	p.24
P200-REC-S-HS	p.24
P200-SAG	p.24
P200-SAG-S	p.24
P200-SAG-S-HS	p.24
P200-SMH	p.09
P200-SMH-HS	p.09
P200-SMH-S	p.09
P200-WPD	p.25
P300-1AHA	p.11
P300-1AHS	p.11
P300-1T110	p.11
P300-1T110-C	p.11
P300-1T110-PB	p.11
P300-1T130	p.11
P300-1T130-C	p.11
P300-1T130-PB	p.11
P300-1T170	p.11
P300-1T240	p.11
P300-1T-B	p.11
P300-1T-H	p.11
P300-2A10	p.12
P300-2A20	p.12
P300-2A40	p.12
P300-2A60	p.12
P300-2A80	p.12
P300-2-B	p.12
P300-2S10	p.12
P300-2S20	p.12
P300-2S40	p.12
P300-2S60	p.12
P300-2S80	p.12
PD-2AD	p.22
PD-2AES	p.20
PD-2AL	p.20
PD-2AM	p.20
PD-2AS	p.20
PD-2SD	p.22
PD-2SES	p.20
PD-2SM	p.20
PD-2SS	p.20
PD-CA-16	p.22
PD-CA-64	p.22
PD-CRA	p.21
PD-CRD-L	p.21
PD-CRD-M	p.21
PD-CRD-P	p.21
PD-CTAD-1T	p.27
PD-CTAD-G	p.27
PD-CTAD-HM	p.27

Order Code	Page
PD-CTAD-IN	p.27
PD-CTAD-LF	p.27
PD-CTAD-LM	p.27
PD-CTAD-SM	p.27
PD-CTAD-WPD	p.27
PD-CTH	p.27
PD-CTTU-150252	p.27
PD-CTTU-600504	p.27
PD-CTTU-606501	p.27
PD-DA-A	p.26
PD-DA-J4	p.26
PD-DA-J6	p.26
PD-DA-K	p.26
PD-DA-P	p.26
PD-DA-W	p.26
PD-EZ-M	p.30
PD-IN-2ES	p.12,14,20
PD-IN-2L	p.14,20
PD-IN-2M	p.12,14,20
PD-IN-2S	p.12,14,20
PD-IN-3L	p.18
PD-IN-3M	p.18
PD-IN-3S	p.18
PD-IN-D	p.12,14,15,22
PD-IT-S	p.29
PD-OSC-A	p.24
PD-PER	p.21
PD-RA330	p.19
PD-RA330-L	p.19
PD-RA-A	p.26
PD-RA-H	p.26
PD-RA-M	p.26
PD-RA-T	p.26
PD-SA-R	p.26
PD-SA-S	p.26
PD-TW-J4	p.26
PD-TW-J6	p.26
SC-C-H125	p.29
SC-C-H70	p.29
SC-ML	p.29
SC-SM	p.29
SC-T-F	p.29
Y900084	p.30
Y900630	p.30
Z019090	p.30
Z182100	p.30
Z299	p.29

Create it 